

GEOPHYSICAL INSTITUTE

UNIVERSITY
OF ALASKA

COLLEGE
ALASKA

VAG RTZ

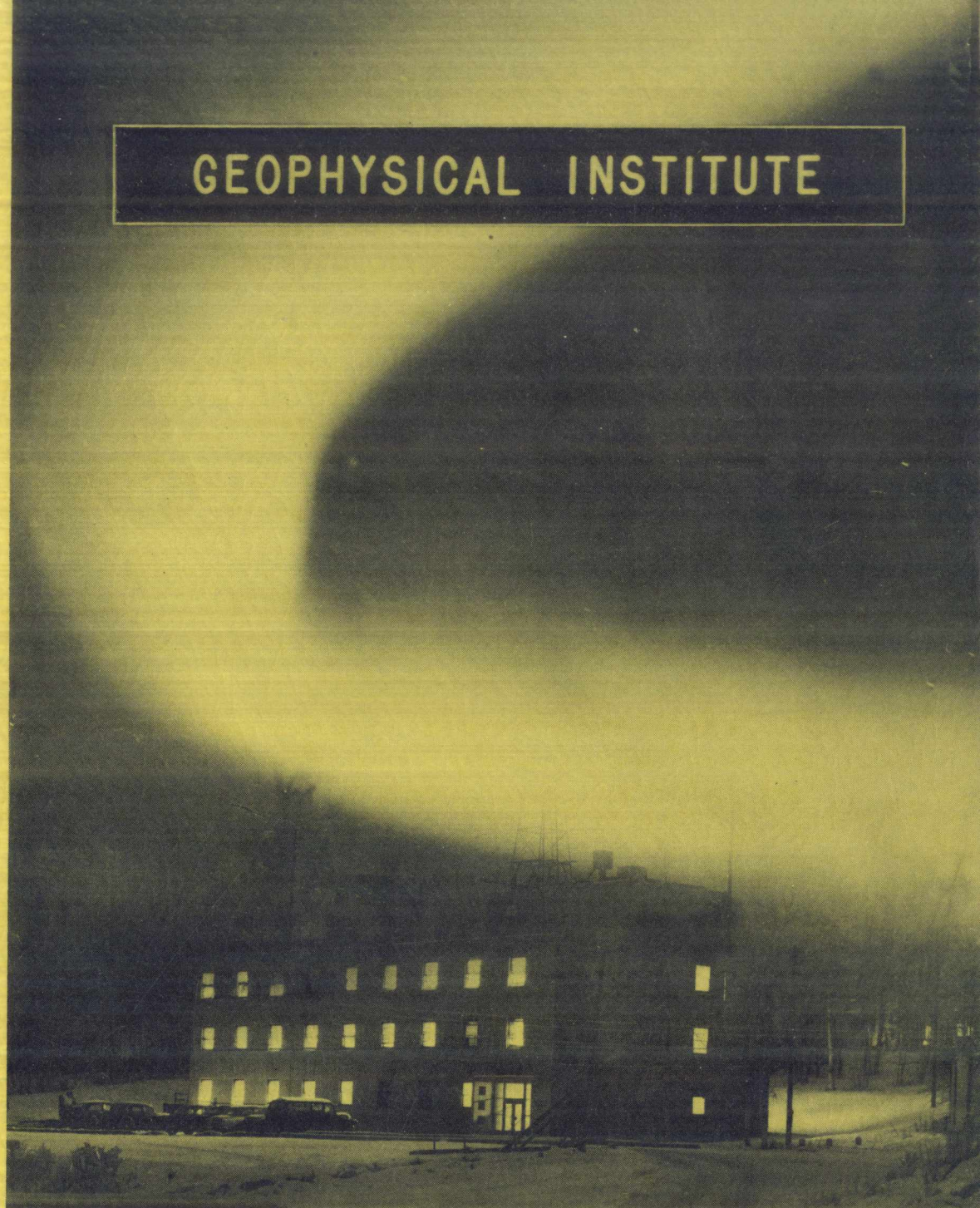

ARCTIC RADIO WAVE PROPAGATION

Task A
Analysis of C-W Data
Final Report

March 1953

Signal Corps Contract	No. DA-36-039-SC-71137
Department of the Army Project	No. 3-99-03-022
Signal Corps Project	No. 182B

Laboratory Procurement Office, Signal Corps Supply Agency
Fort Monmouth, New Jersey

GEOPHYSICAL INSTITUTE
of the
UNIVERSITY OF ALASKA

ARCTIC RADIO WAVE PROPAGATION

Task A
Analysis of C-W Data
Final Report
March 1958

The object of this investigation is to obtain additional information concerning the effects of aurora on high frequency radio signals which is essential to a complete understanding of new modes of propagation that have tactical and strategic applications.

Signal Corps Contract	No. DA-36-039-SC-71137
Department of the Army Project	No. 3-99-03-022
Signal Corps Project	No. 182B

Report Prepared by:

Leif Owren
C. Gordon Little

Report approved by:



C. T. Elvey
Director of the Institute

TABLE OF CONTENTS

	Page
LIST OF FIGURES	ii
SECTION I PURPOSE	1
SECTION II ABSTRACT	2
SECTION III PUBLICATIONS, LECTURES, REPORTS AND CONFERENCES	5
SECTION IV FACTUAL DATA	6
1. Signal Outage Time on Short Paths and Blackouts Compared for Years of High and Low Solar Activity.	6
2. Study of Possible Relations between Transmission over Long Paths and Ionospheric, Magnetic and Solar Phenomena.	13
3. Study of Fluctuation Indices.	15
4. Effects of Ionospheric Absorption and Irregularities on 4 Mc/s Short Path Transmission.	17
5. F2 Region Parameters at College for the Period June 1941 Through December 1956.	45
6. Tables of Monthly Medians Signal Strength June 1949- December 1950 and January 1954-October 1955.	51
SECTION V OVERALL CONCLUSIONS	91
SECTION VI RECOMMENDATIONS	100
SECTION VII PERSONNEL	101

LIST OF FIGURES

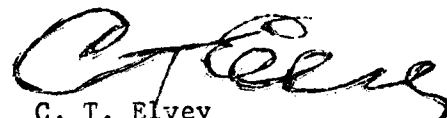
Figure		Page
1	Percentage of Observing Time Lost Each Month Due to Polar Blackouts During 1954	8
2	Percentage of Observing Time Lost Each Month During 1949-50 Due to Polar Blackouts	9
3	Comparison of Average Yearly Outage Time on Short Paths 1949-50 and 1954	11
4	Day-to-Day Variation of Magnetic and Polar Blackout Activity During April 1954	12
5	Day-to-Day Variation of Magnetic and Polar Blackout Activity During October 1949	12
6	Hourly Median Signal Strength on 4 Mc/s Short Paths	19
7	Median Values of the Ratio of Absorption for 22 Events in March 1955	20
8	Reflection from a Surface Corrugated in One Direction (x-propagation)	25
9	Reflection from a Surface Corrugated in One Direction (y-propagation)	25
10	Reflecting Screen with Grating	41
11	Grating Equivalent to "Reflecting Screen with Grating"	41
12A	Monthly Median f_oF_2 at College at Midnight	46
12B	Monthly Median f_oF_2 at College at Noon	46
13A	Daily Variation of f_oF_2 at College During June	47
13B	Daily Variation of f_oF_2 at College During November	47
14A	Monthly Median $h'F_2$ at College Midnight	49
14B	Monthly Median $h'F_2$ at College Noon	49
15A	Daily Variations of $h'F_2$ at College During June	50
15B	Daily Variations of $h'F_2$ at College During November	50

SECTION I**PURPOSE****Task A**

To continue the investigation of the propagation of high frequency radio waves in the arctic by completion of the analysis of existing data which was obtained using c-w techniques.

SECTION II

ABSTRACT

The relation between polar black-outs and signal outages on the short HF transmission paths of "Experiment Aurora" have been analyzed for a year of high solar activity (1949-50) and compared with the results of a similar analysis for a year of low solar activity (1954). In both years there were pronounced peaks in the signal outage time during the equinoctial periods. Detailed comparison shows that the larger peaks occurred during the fall equinox in 1949-50 and the spring equinox in 1954. The same trend is evident in the sunspot number curve for the two yearly periods. Twice as much outage time was caused by black-outs during the high activity year in comparison to the low activity year. The variation in signal outage time is thus found to follow that of the sunspot numbers both seasonally and yearly. The strong correlation of outage time with geomagnetic activity which was established for 1954 is confirmed by the 1949-50 observations.

A study has been made of the possible relations between received signal strength over the long transmission paths and the useable frequencies for these paths for the entire period 1949-55. No correlation is evident. Statements are made concerning the annual trends in the 4, 8 and 12 mc/s signal strengths.

An investigation of fluctuation indices for selected paths and years failed to yield information beyond the fact that the fading rate of the signals generally exceeded the time-resolution of the recording system.

The combined effect of ionospheric irregularities and absorption on the transmission over the 4 mc/s short paths is investigated in detail for the year 1954-55. The mid-day signals on the 4 mc/s short paths showed a reversal of the relative strength recorded over the S-N and E-W paths during the spring equinox of 1955 compared with the winter 1954-55 and summer 1955. The signals were in all

cases propagated by a regular E-layer mode. Continuous observations of the absorption of extraterrestrial radiation carried out with a rotating antenna system during the spring equinox of 1955 made a closer investigation possible.

The absorption observations, which covered the ionospheric reflection points of the HF transmission paths, have revealed that absorption was not by itself sufficient to explain the reversal from stronger S-N to stronger E-W signals during the spring equinox of 1955. The experimental results can be explained by taking into account the effect of irregularities in the reflecting layer.

Two models of the reflecting layer are studied. In the first model the reflecting layer is represented by a surface having a one-dimensional corrugation parallel to the E-W direction. This model leads to a qualitative agreement between theory and observations but is insufficient quantitatively. The model is also unsatisfactory from a theoretical point of view because it is incompatible with the idea that the irregularities consist of ellipsoids having their major axis aligned with the earth's magnetic field. The second model consists of a reflecting screen with a grating of parallel circular cylinders in front (below). When the grating is assumed parallel to the S-N direction and the measured absorption is taken into account, the model leads to quantitative agreement between theory and observations. The second model roughly approximates the effect of field-aligned ellipsoidal irregularities projected onto a horizontal plane. It is concluded that a complete theory of forward scattering of radio waves by field-aligned ellipsoidal blobs together with absorption should be capable of explaining fully the differences in signal strength between the E-W and S-N propagated HF transmissions.

An analysis of the monthly median midnight and noon f_oF_2 and $h'F_2$ values at College for a 15 1/2 year period is presented in the form of a series of

graphs. Although these graphs are primarily restricted to the midnight and noon hours only, sufficient information is given to permit rough estimates of the monthly median critical frequencies and virtual heights for the F2 region for any hour, month or position in the sunspot cycle.

The monthly median values of the hourly received signal strength, measured in log microvolts, are tabulated for June 1949 - December 1950 and January 1954 - October 1955. These years represent respectively periods of high and low solar activity and have been of particular importance in analyses of the HF transmission data.

SECTION III

PUBLICATIONS, LECTURES, REPORTS AND CONFERENCES

No publications or interim scientific reports were issued on Task A during the one year contract period. A symposium on "Effects from Low-Energy Particle Bombardment" was held at the Geophysical Institute on 1-2 March 1956 with participation of scientists from the continental United States. The Third Arctic Radio Wave Propagation Conference of the Geophysical Institute was held on the campus of the University of Alaska on 12 December 1956. The subject of the conference was "Scatter Propagation". It was attended by a number of persons engaged in the field of radio communication in the Territory of Alaska.

SECTION IV

FACTUAL DATA

1. Signal Outage Time on Short Paths and Black-outs Compared for Years of High and Low Solar Activity. (L. A. Ware and Leif Owren.)

The relations between polar black-outs and signal outages on the short 4, 8 and 12 mc/s transmission paths during the year 1954 were analyzed in Interim Scientific Report No. 1, 1955 Contract No. DA-36-039 SC-56739, hereafter referred to as ISR (1955). The analysis indicated with high probability that all signal outages on the short paths were caused by black-outs. The year 1954 fell in a period of low sunspot activity, analysis showing that a deep minimum of the sunspot cycle occurred during the spring that year.

It is therefore important to study also the correlation between black-outs and short path signal outages for a year of high solar activity and compare the results for the periods of high and low activity. The year of highest solar activity during the "Experiment Aurora" transmission experiment was 1949-50. We have therefore selected this year for analysis.

To provide a basis for comparison it is appropriate first to summarize the methods and results of the 1954 study.

The times of polar black-outs during 1954 were determined from the ionograms obtained with the C-3 ionosphere sounder at College as well as from measurements of the absorption of extraterrestrial waves. The subsequent analysis showed that about 50 per cent of the signal outage time occurred simultaneously with black-outs recorded on the vertical incidence sounder. By counting as periods of absorption all times when the minimum frequency recorded on the ionosphere sounder exceeded 1.0 mc/s ($f_{\min} > 1.0$ mc/s), the percentage of simultaneous occurrence of signal outage over the short paths and black-outs increased to 80 per cent. Arguments were advanced in ISR 1955 which make it probable that almost all signal outages in 1954 were caused by

7

ionospheric absorption and essentially none due to lack of sustaining ionization in the propagating layer.

The results of the analysis for 1954 were given in ISR 1955 in the form of a diagram showing the percentage of observing time lost due to polar black-outs over each short path for each month. This diagram is reproduced here as Fig. 1 for easy reference. It shows pronounced peaks in observing time lost due to black-outs during the equinoctial months for all six short paths. An analysis was also made of the relation between polar black-outs and geomagnetic K-index at College during 1954. It was found that seasonally the black-outs occurred most frequently during the equinoctial periods and that the K-index also reached its highest average monthly values during these same periods. A detailed comparison between the daily variation of black-outs and magnetic activity for the month of April 1954 similarly showed a fairly high degree of correlation (see Fig. 4 reproduced from ISR 1955).

An analysis of the relationship between signal outages and polar black-outs for the short paths during 1949-50 has been carried out exactly in the same way as the analysis for 1954. The absorption periods have been determined from the C-3 ionograms using the same criteria i.e. by considering as periods of absorption both the times when black-outs were scaled as such and the periods when f_{\min} exceeded 1.0 mc/s. The results are shown in Fig. 2 which give the percentage of observing time lost each month due to polar black-outs during 1949-50 for the six short paths. The east-west paths (Northway-College) appear in the top diagram of the figure and the south-north paths (Anchorage-College) in the bottom diagram. The diagram in the middle of Fig. 2 indicates the variation in the monthly Relative Sunspot Number during 1949-50. When comparing Fig. 1 with Fig. 2 it should be noted that the horizontal scale in Fig. 1 runs from January through December 1954 while in Fig. 2 the same scale starts with June 1949 and continues through May 1950.

1954 SHORT PATHS

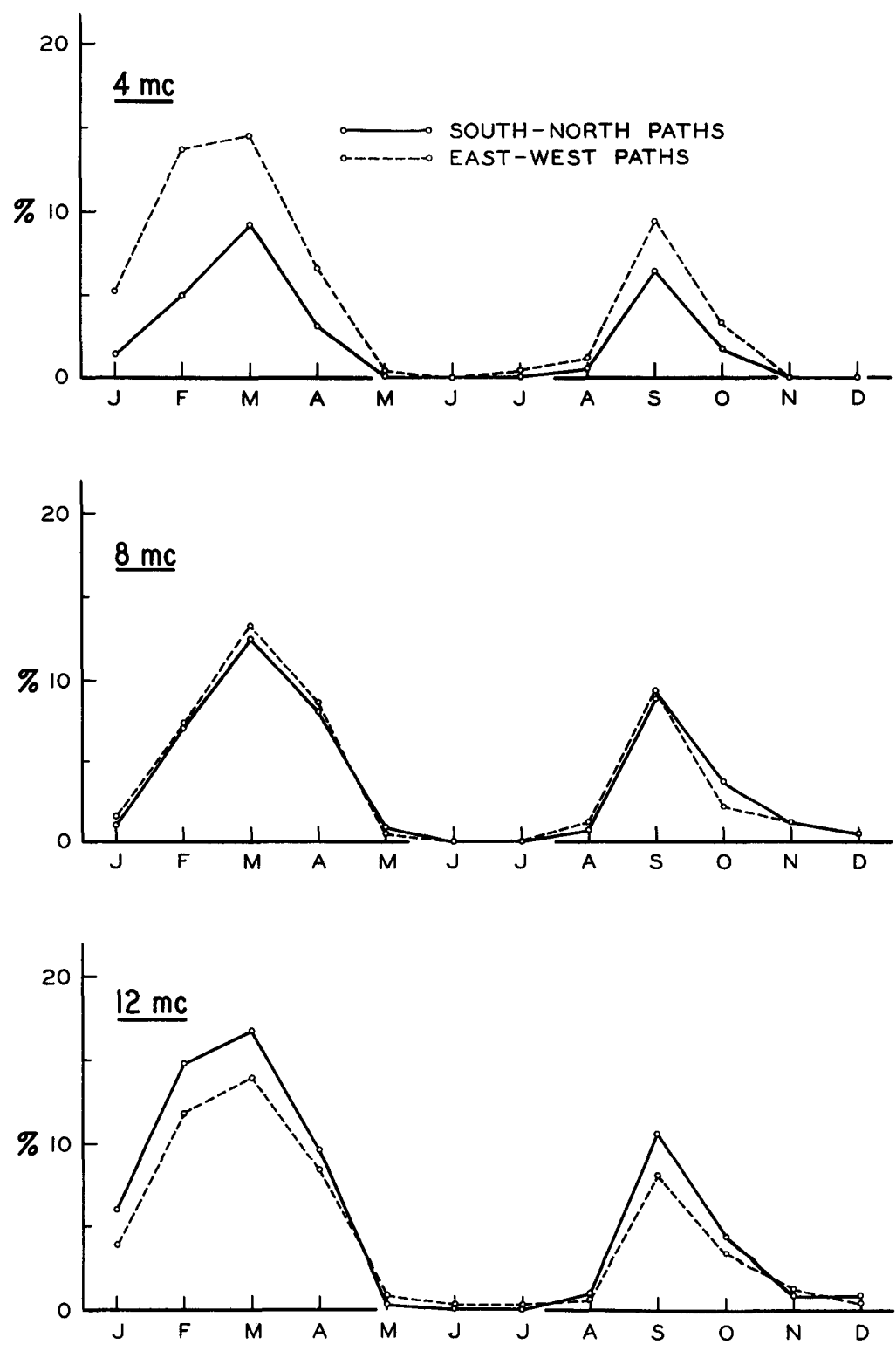

PERCENTAGE OF OBSERVING TIME LOST EACH MONTH DUE TO POLAR BLACKOUTS.

Fig. 1

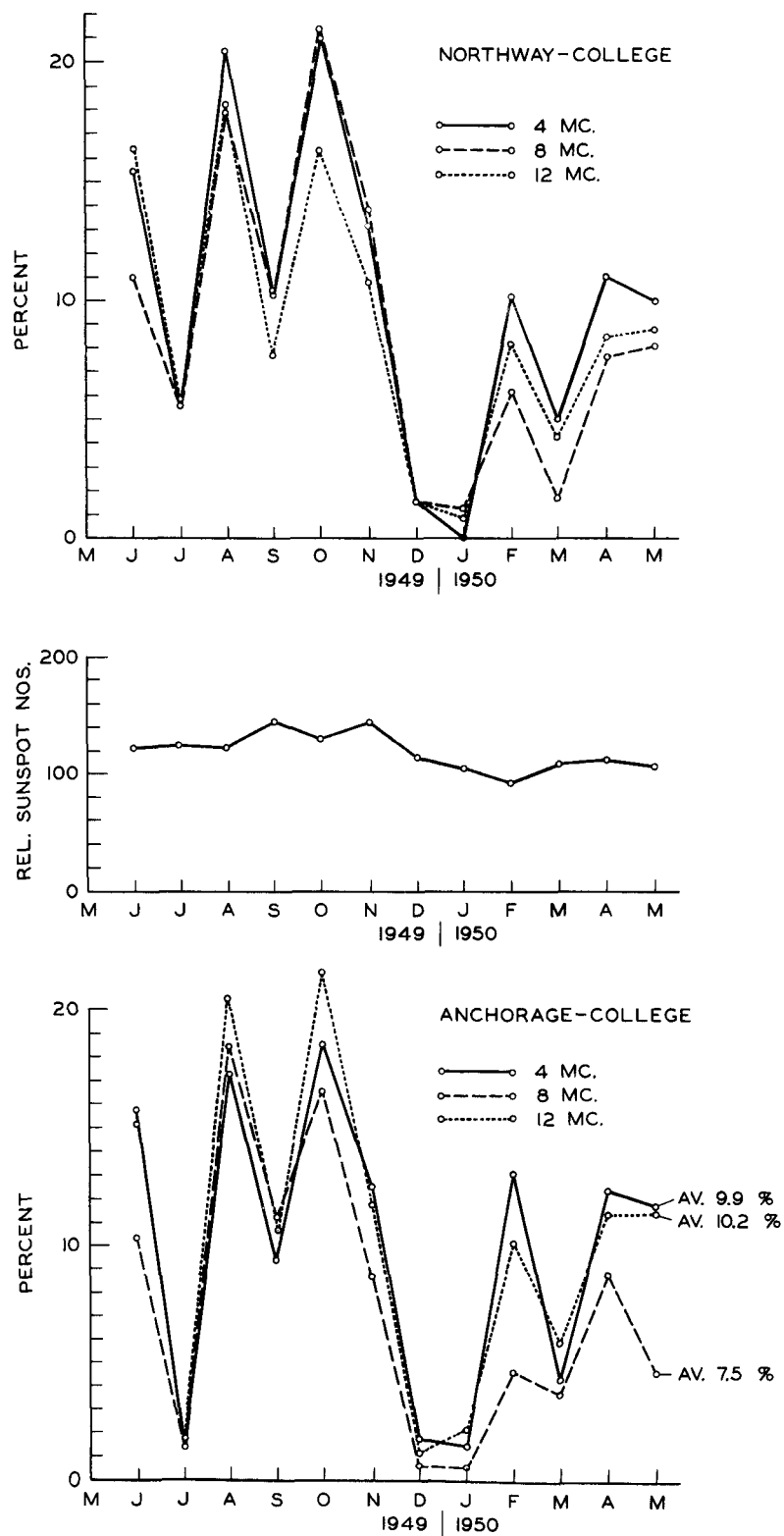

Percentage of Observing Time Lost Each Month During 1949-50 Due to Polar Blackouts

Fig. 2

Inspection of Fig. 2 shows that pronounced peaks in observing time lost due to black-outs occurred during the equinoctial periods of 1949-50 as already noted for the year 1954. A more detailed comparison of Figs. 1 and 2 brings out the fact that while in 1954 the larger peak in signal outage occurred during the spring equinox and the smaller during the fall equinox, the opposite was the case in 1949-50. The explanation for this reversal is indicated by the middle diagram in Fig. 2. The relative sunspot number curve shows peaks exceeding 140 for September and November 1949 while the relative maximum in March and April 1950 only reached about 110. Actually the sunspot curve stayed above 110 throughout 1949, then fell to a minimum of about 95 in February 1950, increasing again during the two following months. The ratio of the equinoctial peaks in outage time is of the order of 2 to 1 for 1949-50 while the corresponding ratio for 1954 is about 1.5 to 1 or less. The relative sunspot numbers showed the following variation during 1954:

Table 1.1 Monthly Relative Sunspot Numbers during 1954

Jan	Feb	Mar	Apr	May	Jun	Jul	Aug	Sep	Oct	Nov	Dec
0.2	0.5	10.9	1.8	0.8	0.2	4.8	8.4	1.5	7.0	9.2	7.6

Thus, in 1954, the largest monthly sunspot number was recorded in March with a value of 10.9 while the second largest of 9.2 occurred in November. The values for August and September, respectively 8.4 and 7.0, were not much below the November value. This variation is consistent with the idea that the larger equinoctial peak occurs for the larger sunspot number.

Since the curves of percentage outage time in Figs. 1 and 2 are derived from similar data treated by the same method, the magnitudes are directly comparable. It is therefore evident that the percentage of observing time lost due to black-outs was considerably higher during 1949-50 than 1954 both when comparing the equinoctial periods and the years as a whole. Fig. 3 further illustrates the latter point and

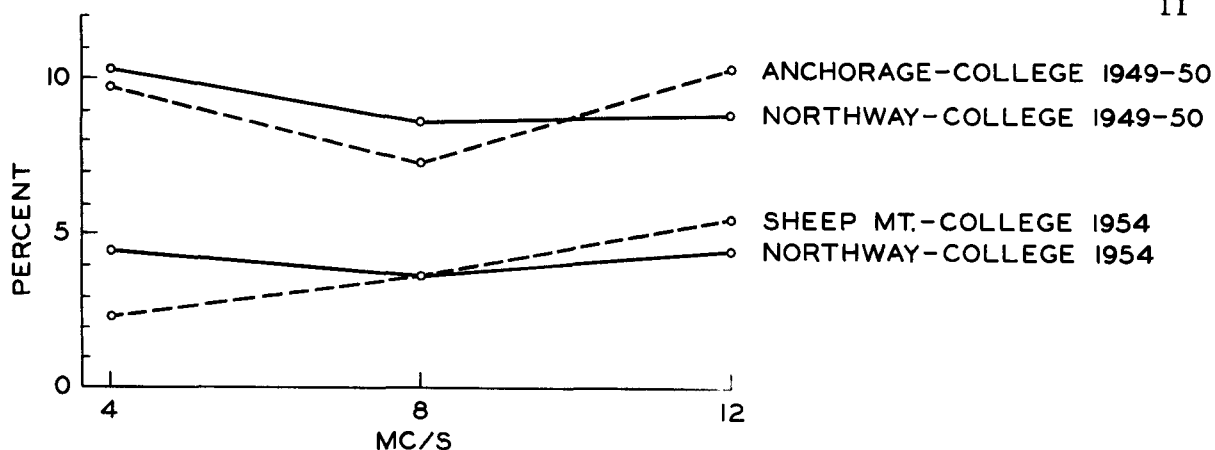

Comparison of Average Yearly Outage Time on Short Paths
1949-50 and 1954

Fig. 3

also shows how the relative behavior of the different frequencies and propagation directions. This figure gives the average yearly per cent of signal outage due to black-outs for each short 4, 8 and 12 mc/s path in both 1949-50 and 1954. The diagram clearly indicates that about twice as much observing time was lost on any given short path in 1949-50 as on the same path in 1954. In both years the variation in percentage outage time as a function of frequency and propagation direction follows the same trend. At 4 mc/s the smallest loss occurred on the S-N path and at 12 mc/s on the E-W path in both years.

It is well known that geomagnetic activity is strongly correlated with solar activity. Also, the study in ISR 1955 showed a good correlation during 1954 between the occurrence of black-outs and increases in the geomagnetic K-index for College both on a seasonal and on a daily basis. For the sake of completeness the relationship between the black-out time and the variation in geomagnetic activity has also been studied for the year 1949-50. Curves have been plotted for the percentage of black-out time for each month of that year together with the monthly mean of the daily sum of the magnetic K-index for College. The results are similar to and confirm those obtained for 1954. Fig. 5 shows as a sample illustration the curves for October 1949. This figure may be compared with Fig. 4 giving the similar curves for April 1954.

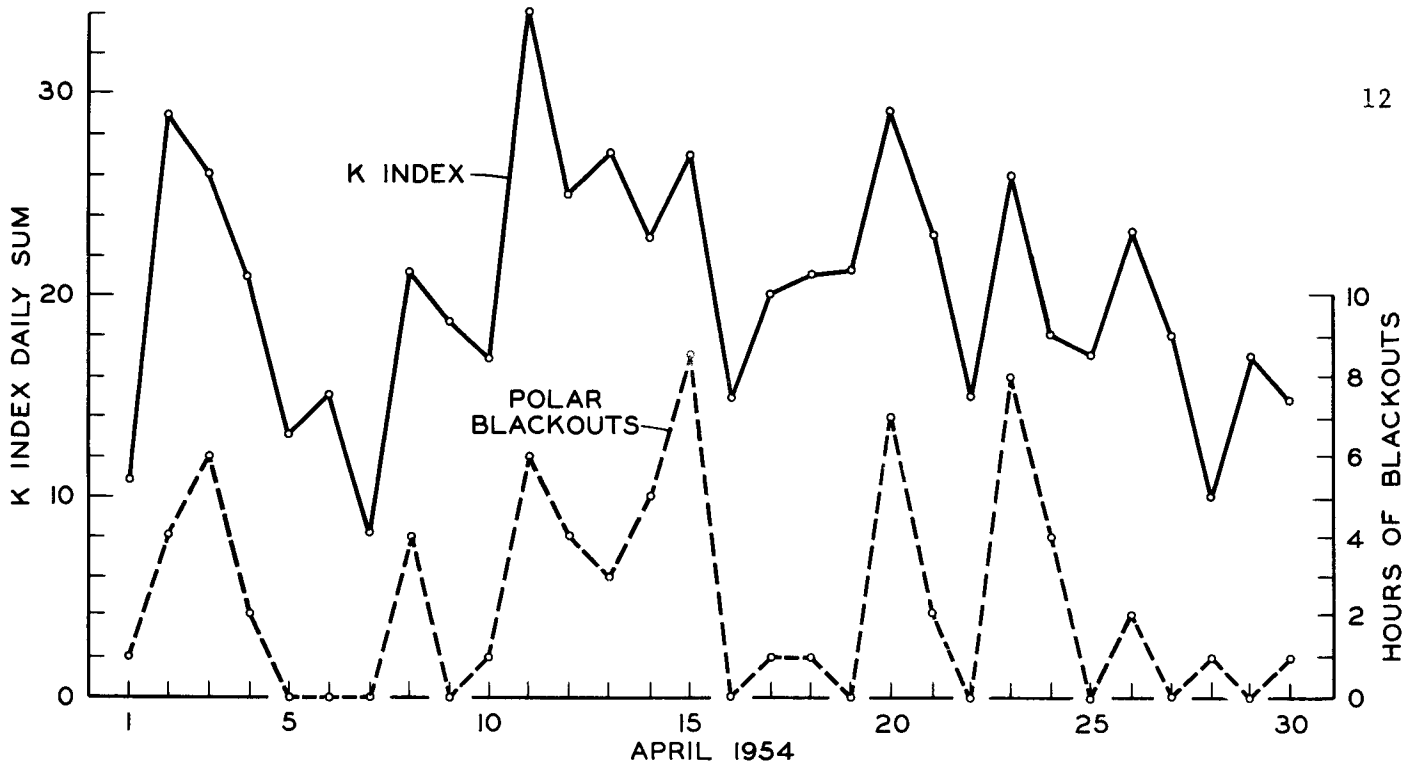

DAY-TO-DAY VARIATION OF MAGNETIC AND POLAR BLACKOUT ACTIVITY DURING APRIL 1954

Fig. 4

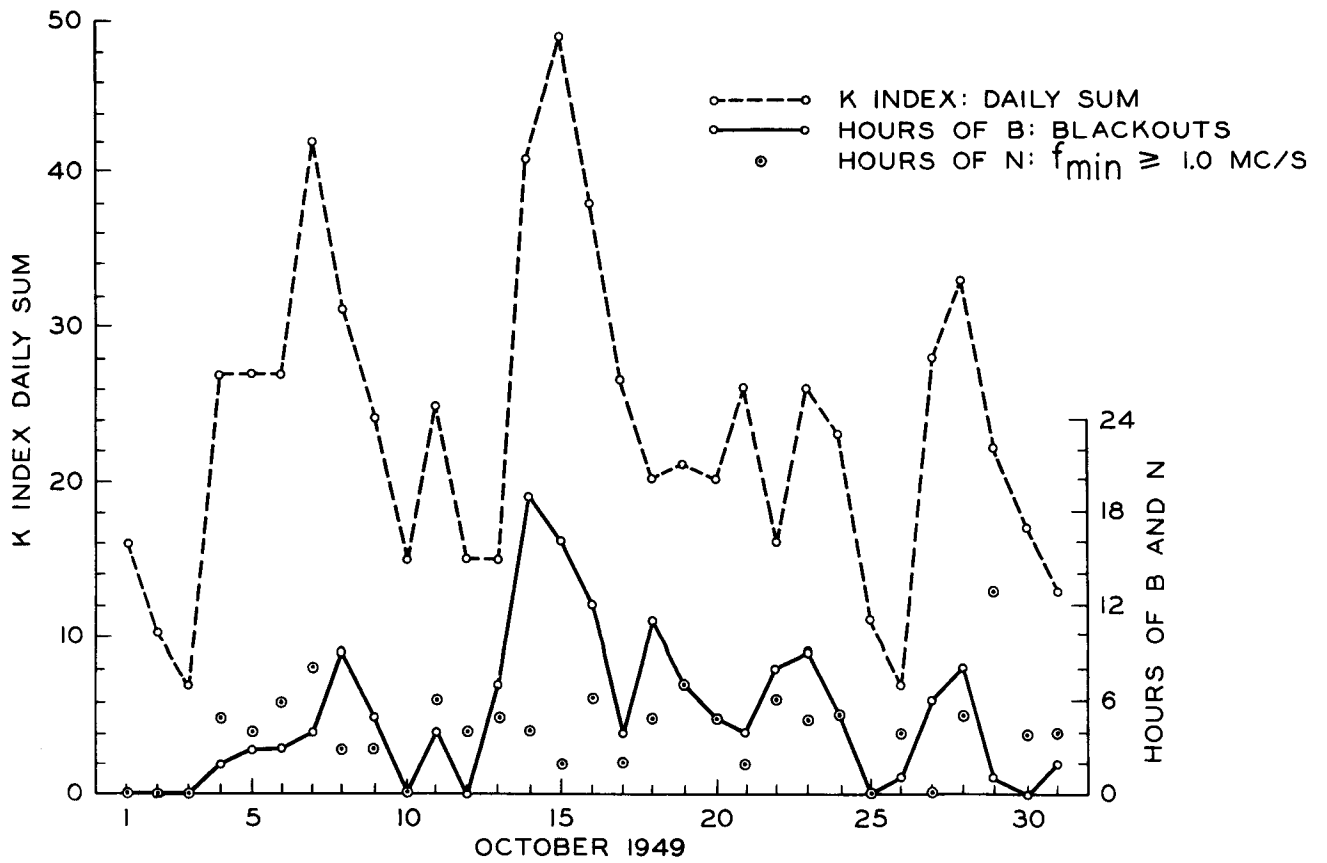

Day-to-Day Variation of Magnetic and Polar Blackout Activity During October 1949

Fig. 5

Three main conclusions may be drawn from this comparison of 1949-1950 and 1954 data. First, it has been shown that signal outages on short HF paths near the auroral zone are due to ionospheric absorption in both years of high and low solar activity. Second, the outage time is correlated with magnetic activity, and shows marked equinoctial maxima. Third, the signal outage time varies with the sunspot number, being greater in years of high solar activity than in years of low activity. These facts are consistent with the theory that the signal outages are caused by ionospheric absorption resulting from impact on the upper atmosphere of particle streams from the sun.⁽¹⁾ Such corpuscular bombardment of the high latitude ionosphere will be more frequent in years of high than low solar activity, and has been found to be more effective during equinoctial than solstitial periods.

1. Chapman S. and Little, C.G., "The Nondeviative Absorption of High-Frequency Radio Waves in Auroral Latitudes," J. ATMOS. TERR. PHYS., Vol. 10, pp.20-31; January 1957.
2. Study of Possible Relations between Transmission over Long Paths and Ionospheric, Magnetic and Solar Phenomena. (L. A. Ware).

A search has been made for possible detailed relations during the period 1949-55 between the received signal strengths on 4, 8 and 12 mc over the long transmission paths and the maximum usable frequencies (MUFs) for these paths as determined on the basis of ionospheric sounder data for College. The hourly median signal strength (measured in log microvolts) for the hours 00-01 and 12-13 local time were averaged for each of the four yearly seasons (winter, spring, summer and fall) and compared with average seasonal MUF for local midnight and noon.

No definite correlation trends could be established, indicating that the average signal strength is not related in a simple manner to the average critical frequencies or MUFs. Thus, other ionospheric parameters must be considered also.

The average seasonal values of signal strength for 1949-55 were further compared with the average seasonal relative sunspot numbers as well as the average values of

the magnetic K-index for College at local and Greenwich midnight. Again, no correlation was evident.

Inspection of the curves for the average seasonal signal strengths over the long paths during the years 1949-55 permit the following observations:

- i. Transmission on the frequency of 4 mc was consistently poor throughout the period 1949-55. However, a significant increase in signal strength took place between the fall of 1953 and the spring of 1954 (sunspot minimum) and the level of signal strength thereafter remained more or less constant at this higher level for the rest of the period.
- ii. The annual trend in signal strength from 1949-1955 is upward for the frequency of 8 mc but downward for 12 mc. On the average, transmission on 8 mc was best during the night.
- iii. In 1952 transmission was much better on 8 mc than on 4 or 12 mc. The received signal strength on 8 mc had a marked peak during 1952, and during this year day and night transmission was about equally good on this frequency. In 1952 there was a noticeable dip in the average received signal on 12 mc, both during day and night. This opposite behaviour of the 8 and 12 mc signal strengths remains unexplained.
- iv. In 1955 transmission improved on all frequencies.

The summary given above appeared in Quarterly Progress Report No. 2. Later re-examination of the data has shown that no additional information can profitably be extracted. The curves prepared in course of the investigation fail to show any clear-cut trends and do not warrant inclusion in the present report.

3. Study of Fluctuation Indices. (Leif Owren).

The two basic quantities scaled from the field intensity records obtained during "Experiment Aurora" are the signal-in-time and the hourly median signal strength. The evaluation of the propagation conditions over the different transmission paths would be facilitated and made more meaningful if in addition information on the average hourly fading characteristics of the received signals could also be derived from the records. However, due to slow tape speed adopted for the recording (1 1/2 inches per hour), fading rates and magnitudes cannot be scaled. It was hoped that useful information could still be obtained by scaling instead two quantities termed respectively the amplitude fluctuation index and the rate fluctuation index. The fluctuation indices can be derived by visual estimates of the short-time variations in signal amplitude and the frequency of these variations averaged over each hourly period.

Similar indices have been used with advantage in the study of radio star scintillations¹. The latter investigations showed that the fluctuation rate rather than the fluctuations in amplitude was the more important index.

The fluctuation indices were evaluated on a scale of 0, 1, 2, 3 with 0 denoting essentially no variation and 3 very large variations. The rate numbers, in particular, had the following meaning:

- 0 no noticable oscillation
- 1 slow oscillation
- 2 medium oscillation
- 3 fast oscillation - appearing as solid block on the records (no separation between up and down strokes of the pen).

The program set-up called for scaling the fluctuation indices for 4 and 8 mc/s on the short and long paths both S-N and E-W during the periods June 1949 - December 1950 and January 1954 - October 1955, i.e. for periods of both high and low solar activity.

The scaling was actually only carried through for the 4 mc/s long paths S-N and E-W and the 8 mc/s short paths S-N and E-W.

Inspection of the data then revealed that the fluctuation rate of category 3 predominated to an overwhelming degree. Thus no useful information beyond the fact that the fluctuation rate was almost always the largest readable could be obtained. Since the interpretation of the amplitude variations would in any case be somewhat doubtful and could only be expected to become meaningful when compared with the rate variations, the project was abandoned at this stage.

The result that the fluctuation rate was nearly always 3 probably only reflects the fact that the fading rate of the signals generally exceeded the time-resolution of the recording system.

This fact is consistent with the backscatter sounding observations performed at 12 mc/s under Task B of this contract which showed fading rates of the order of 1 to 6 cycles per second for groundscatter echoes propagated via the regular F and E as well as sporadic E ionization².

The range of the fading rates for the 4 and 3 mc/s transmissions can be estimated from these observations by allowing for the frequency dependence and taking into account that two reflections rather than one is involved in the backscatter soundings. The resulting fading rates exceed considerably the time-resolution of the records, and thus confirm the tentative explanation of the high fluctuation rate given above.

References:

1. M. Ryle and A. Hewish, Monthly Notices of the Royal Astronomical Society, 110, 384, 1950.
2. L. Owren and R. A. Stark, Arctic Radio Wave Propagation, Final Report Task B, Contract No. DA-36-039 SC-71137, October 1957, p. 60.

4. Effects of Ionospheric Absorption and Irregularities on 4 Mc/s Short Path Transmission. (G. C. Rumi and L. Owren.)

Studies of the transmission data from "Experiment Aurora" have shown that the signal outages on the short propagation paths Anchorage - College, Northway - College and Sheep Mountain - College were almost exclusively caused by ionospheric absorption (cf. ISR 1955¹, FR 1956² and Section 1 of this report). The absorption correlated with the signal outages was of non-deviative nature, occurring below the reflecting regions and primarily during the daytime.

In FR 1956² the possible difference between east-west and south-north propagation was considered. It was found that a statistically significant difference in signal-in time existed for the 12 mc/s short paths and perhaps for the 4 mc/s short paths. In the case of the 12 mc/s short paths the data revealed a larger percentage of signal in time in the east-west than in the south-north direction. It was shown that (during 1949-50) propagation over the short paths at 12 mc/s was highly dependent on sporadic ionization. The suggestion was made that the difference between east-west and south-north propagation was due to a preferential orientation of sporadic ionization along parallels to the auroral zone. The 4 mc/s data indicated somewhat more efficient propagation over the south-north than over the east-west short path. No explanation was attempted in view of the marginal magnitude of the effect.

Recently, observations of the ionospheric absorption of extraterrestrial radiation made with a rotating antenna at College during the spring equinox of 1955 have become available.³ This experiment explored the absorption in a ring-shaped area centered on College and limited by radii of approximately 200 and 500 kilometers. The ionospheric reflection points for both the short and long transmission paths of "Experiment Aurora" fall within this area. Therefore, it has become possible to make a direct comparison between the strength of the received signal and the relative absorption for the different paths during March 1955. By use of the established fact

that the daytime absorption reaches its yearly maximum during the equinoctial periods in the auroral zone regions and reference to the vertical incidence sounding data, the comparison may be extended over the year 1954-55.

The signals received at College over the 4 mc/s short paths have been selected for closer study. There are three reasons for making this particular choice. First, the 4 mc/s short path signals are among those for which there is an indication of a preferential direction of propagation. Second, the daytime propagation mode can be established with some certainty as a regular E-layer mode during the period considered (see below). Third, comparison of the hourly median signal strengths for the Winter 1954-55, Equinox 1955 and Summer 1955 show that while the mid-day signals were somewhat stronger for the south-north than the east-west path during the winter and summer months mentioned, this trend was reversed during the equinoctial period (see Fig. 6). The fact that the equinoctial recordings of signal strength are bracketed timewise between recordings showing the opposite trend of relative signal strengths gives assurance that the observed effect is real and not due to changes in the experimental conditions. These factors all combine to make an analysis of the 4 mc/s short path transmissions particularly interesting.

During March 1955 twenty-two major absorption events were observed with the rotating antenna equipment. Quiet day curves of the extraterrestrial signals were prepared as a function of sidereal time for four azimuths, geographical NW, NE, SE and SW. The observations for the disturbed periods were then scaled against the four quiet day curves. The maximum values of radio absorption in the NW, SE and SW directions were determined relative to the absorption in the NE direction for the 22 events. Taking the absorption in the NE quadrant equal to unity, the ratios for the other quadrants, expressed in decibels, were respectively: NW = 0.95, SE = 0.75, and SW = 0.65. Thus the NE direction typically showed the greatest absorption and the SW direction the least. The situation is depicted in Fig. 7.

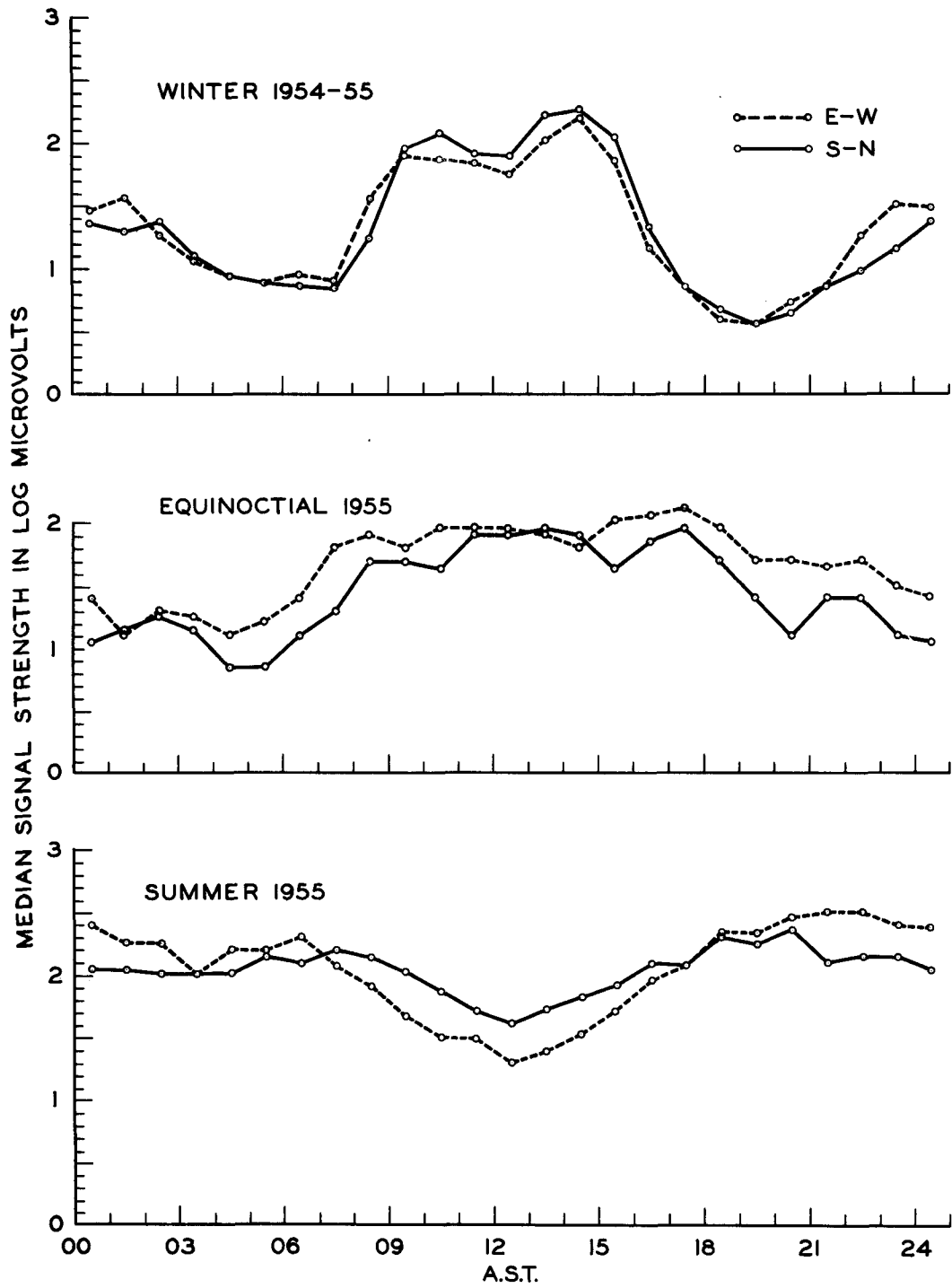

HOURLY MEDIAN SIGNAL STRENGTH ON 4 MC SHORT PATHS

Fig. 6

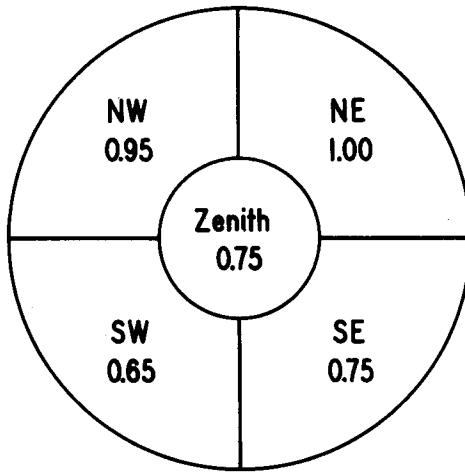

Median Values of the Ratio of Absorption for 22 Events in March 1955

Fig. 7

The ionospheric reflection points for the two 4 mc/s short paths are located SE relative to College for the E-W path and due S for the S-N path. From the absorption measurements one would expect the ratio: (signal strength E-W) / (signal strength S-N) to increase during the equinoctial period compared with the winter and summer periods, i.e. an enhancement of the trend already observed during the winter and summer months. As noted above, the recorded signal strength on the contrary showed a weakening of the S-N relative to the E-W transmission. We are therefore led to infer that some complementary mechanism, more efficient than the absorption, makes propagation in the E-W direction more favorable than S-N propagation during the equinoctial months.

We observe that deviative absorption near the level of reflection, the effect of which is not included in the absorption measured by the extraterrestrial technique, cannot explain the reversal of relative signal strengths. The relationship between non-deviative and deviate absorption has been studied in detail by Gosh⁴, and illustrated in a number of representative diagrams (cf. Mitra, The Upper Atmosphere, 2nd ed., Ch. VI pp. 199-201). Deviative absorption shows the same trend as the non-deviative and therefore cannot provide the mechanism we seek.

An explanation of the experimental results can be obtained if one takes into account that the reflecting layer does not present a smooth, horizontally stratified surface to the incident radio waves but has an irregular distribution of electron density which makes the reflecting surface appear as rough. It is now well established that the irregularities have an anisotropic distribution of electron density and are best described in terms of ellipsoidal blobs whose major axis is aligned with the geomagnetic lines of force. A full theory of the transmission of radio waves via an ionosphere with such properties would appear to require the solution of the problem of forward scattering of waves obliquely incident on a random collection of field-aligned blobs of ionization having the shape of prolate spheroids. This mathematically

difficult problem will not be considered here. We shall be content to show that the experimental results can be explained at least qualitatively using simpler models of the reflecting layer.

One simple model, analyzed mathematically by Fein⁵, is to consider the reflecting layer as represented by a surface corrugated in one dimension. Fein⁵ derived an expression for the angular spectrum for radio waves propagating in the direction normal to the corrugation. We shall need also the corresponding expression for the angular spectrum of waves propagating parallel to the corrugation. In the following we state the formula obtained by Fein⁵ and the underlying assumptions and derive by Fein⁵'s method the other required expression for the angular spectrum. The relative signal strengths of waves propagating normal and parallel to the corrugation can then be discussed and the results applied to the experimental observations. We shall assume that the corrugated reflecting screen involved in daytime propagation over the 4 mc/s short paths represents the E-layer. Before proceeding with the analysis, we justify this assumption by giving evidence that the daytime propagation mode must have been a regular E-layer mode during the spring equinoctial period in 1955. The following tables list the hourly median critical frequency and virtual height of the E-layer during March and April 1955 deduced from vertical incidence soundings at College.

Table 4.1. Hourly Median Critical Frequency of E-layer

Hour 150° WMT	08	09	10	11	12	13	14	15	16	17
March 1955										
f_oE mc/s	2.0	2.2	2.4	2.4	2.5	2.4	2.4	2.2	2.0	1.6
April 1955										
f_oE mc/s	2.4	2.6	2.6	2.7	2.8	2.8	2.7	2.5	2.4	2.1

Table 4.2. Hourly Median Virtual Height of E-layer

Hour 150° WMT	08	09	10	11	12	13	14	15	16	17
March 1955										
h'E km	110	110	110	110	110	110	110	110	120	-
April 1955										
h'E km	110	100	100	100	100	100	100	100	110	110

The distance, D, between Northway or Sheep Mountain and College is approximately 360 km. The obliquity factor to be used with the f_oE values is therefore

$$(1 + D^2/4h)^{1/2} = (1 + 180^2/105)^{1/2} = 2.0$$

The hourly median of the oblique incidence penetration frequency, $f_o'E$, for the 4 mc/s short paths thus had the values given in Table 4.3 during March and April 1955.

Table 4.3. Hourly Median Oblique Incidence Penetration Frequency

Hour 150° WMT	08	09	10	11	12	13	14	15	16	17
March 1955										
$f_o'E$ mc/s	4.0	4.4	4.8	4.8	5.0	4.8	4.8	4.4	4.0	3.2
April 1955										
$f_o'E$ mc/s	4.8	5.2	5.2	5.4	5.6	5.6	5.4	5.0	4.8	4.2

These frequencies should be compared with the actual transmission frequencies

Northway - College: 4.095 mc/s

Sheep Mt.- College: 4.240 mc/s

The comparison shows that the transmission frequencies were indeed below the oblique incidence penetration frequencies during the daytime in March and April 1955, and that the assumption of a regular E-layer daytime propagation mode is well justified.

The geometrical situation considered by Feinstein⁵ is illustrated in Fig. 8. The transmitter is located at O, the receiver at Q, while the reflecting surface $h(x,y,t)$ is assumed corrugated in one space-dimension, x . The shape of the surface is also a function of time. Thus, $h = h(x,t)$. The average received power at Q is given by

$$P_Q = (1/2Z_0) (E_0/(D_1 + D_2))^2$$

where Z_0 = the impedance of free space, E_0 = the amplitude at unit distance from the source.

The following assumptions have been made,

1. the differences in range and obliquity factor for adjacent paths are negligible,
2. a phase term $\exp(ikh^2 \sin^2 \theta / \bar{D})$ with $1/\bar{D} = 1/2(1/D_1 + 1/D_2)$, has been neglected which is permissible as long as the angle of incidence on the corrugated screen is far from grazing,
3. the distribution of the height function, h , at any two positions is of the bivariate normal type with variance $\overline{h^2}$ (cf. Feller, Probability Theory).

Feinstein infers from an analysis of the above model that the average energy received is identical with that resulting from a specular reflection, although the angular distribution of this energy may be considerable different. It should be noted that this conclusion is only valid in the absence of absorption. When absorption is present one would expect the strength of the reflected signal to depend on the angular energy distribution, a higher attenuation of the signal being associated with the broader angular distribution.

The expression for the angular spectrum of a wave-field propagating in the x -direction is given by Feinstein (loc. cit.) as,

$$p(\varphi) = e^{-a} \delta(\varphi) + e^{-a} \sum_{n=0}^{\infty} (a^n kL \cos \theta) / (n! [\pi n]^{1/2}) \cdot \sec^2 \varphi \cdot \exp[-k^2 L^2 \cos^2 \theta / n) \tan^2 \varphi]$$

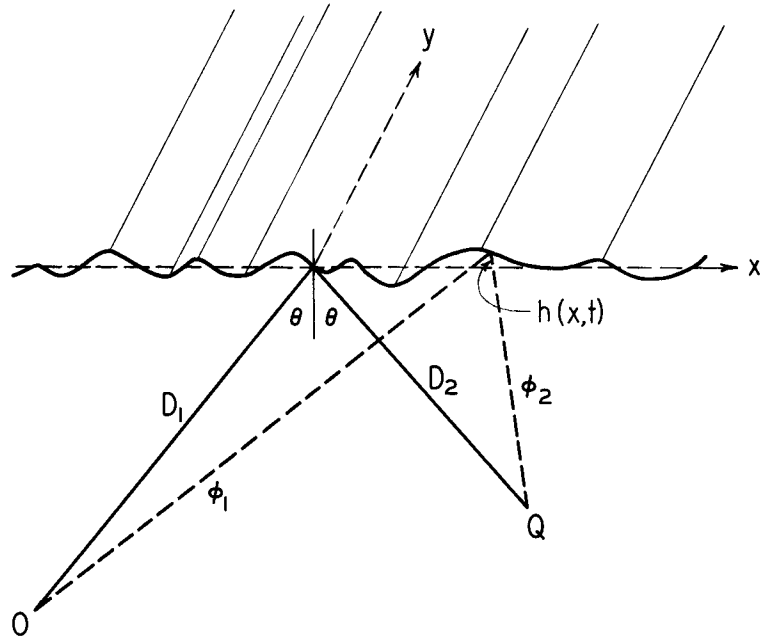

REFLECTION FROM A SURFACE
CORRUGATED IN ONE DIRECTION
x, O AND Q ARE IN THE SAME PLANE

Fig. 8

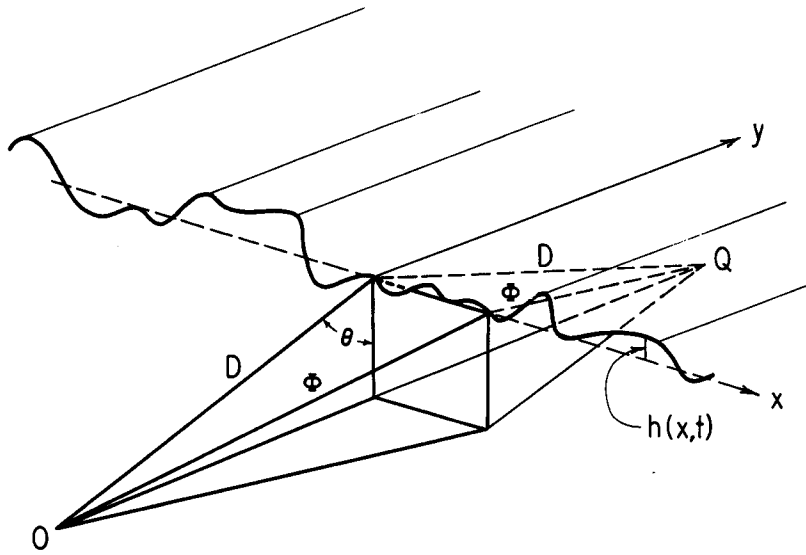

REFLECTION FROM A SURFACE
CORRUGATED IN ONE DIRECTION

Fig. 9

with $a = 4k^2 h^2 \cos^2 \theta$

$$\varphi = \arctan(x \cos \theta / \bar{D})$$

$$k = 2\pi/\lambda$$

L = scale of turbulence

and $\rho(\mathbf{z})$ = correlation coefficient $\propto \exp(-z^2/L^2)$

The expression above is valid for relatively large kl consistent with the supplementary condition $g = \bar{D}/kL^2 \cos^2 \theta \gg 1$.

The angular spectrum for propagation in the y -direction must be derived. The relative geometry is shown on Fig. 9. For this case we have

$$E_Q = [kD/\pi]^{1/2} (E_0 \cos \theta) / (2D^2) \int_{-\infty}^{+\infty} \exp[2ik\varphi - i\omega_0 t] dx$$

under the conditions stated above, where

$$\varphi = [(D \sin \theta)^2 + x^2 + (D \cos \theta + h)^2]^{1/2}$$

By expanding the phase to second order terms we have

$$\begin{aligned} 2\varphi &= 2D + x^2/D + 2h \cos \theta + h^2/D - h^2 \cos^2 \theta / D \\ &= 2D + 2h \cos \theta + (x^2 + h^2 \sin^2 \theta) / D \end{aligned}$$

Here too the phase term $h^2 \sin^2 \theta / D$ has to be neglected since it is comparable to $2kL \cos \theta$ only at extreme grazing incidence. Then

$$E_Q = (E_0/D^2) [kD/4\pi]^{1/2} \cos \theta \int_{-\infty}^{+\infty} \exp[ikx^2/D + 2ikh \cos \theta - i\omega_0 t] dx$$

and

$$\bar{P}_Q = (E_0^2/Z_0 D^3) (k \cos^2 \theta) / (8\pi).$$

$$\begin{aligned} \text{Re} \left[\lim_{T \rightarrow \infty} (1/2T) \int_{-T}^{+T} dt \int_{-\infty}^{+\infty} \int_{-\infty}^{+\infty} \exp[(ik/D)(x^2 - x'^2) + \right. \\ \left. 2ik \cos \theta [h(x,t) - h(x',t)] \right] dx dx' \end{aligned}$$

where Z_0 is the impedance of free space. By assuming again that h is normally

distributed with variance h^2 and independent of time, that the distribution of

$(\Delta h)_{x-x'}$ is bivariate normal, and by interchanging integration over time with

integration over probability in \bar{P}_Q , we get

$$\bar{P}_Q = (E_0^2 / Z_0 D^3) (k \cos^2 \theta) / (8\pi) \int_{-\infty}^{+\infty} dx dz \exp[(ik/D)(2xz - z^2)].$$

$$\exp[-4k^2 \cos^2 \theta \cdot h^2 (1 - \rho(z))]$$

with $a = 4 k^2 L^2 \cos^2 \theta$ we obtain

$$p(x) = (k/\pi D) \int_{-\infty}^{+\infty} dz \exp[ik/D(2xz - z^2)] e^{-a} \sum_{n=0}^{\infty} (a^n/n!) e^{-nz^2/L^2}$$

$$\text{when } \int_{-\infty}^{+\infty} p(x) dx = 1.$$

$$p(x) = e^{-a} \sum_{n=0}^{\infty} (a^n/n!L) \exp[-nx^2/(L^2)(1+n^2\gamma^2)].$$

$$\frac{\cos[(kx^2/D)/(1+n^2\gamma^2) + (1/2)\text{arc tan}(n\gamma)]}{[\pi\gamma]^{1/2} [1+n^2\gamma^2]^{1/4}}$$

where $\gamma = D/kL^2$.

Steps analogous to the ones used for propagation in the x-direction lead to

$$p(\varphi) = e^{-a} \delta(\varphi) + e^{-a} \sum_{n=0}^{\infty} (a^n/n!) kL/[\pi n]^{1/2} \exp[-k^2 L^2/n \tan^2 \varphi] \cdot \sec^2 \varphi$$

with $\tan \varphi = x/D$.

We want to calculate the difference between the two $p(0)$ for x and y propagation.

Such calculations require a knowledge of a and L . a essentially controls the aperture of the angular spectrum and L controls the difference $p_y(0) - p_x(0)$.

a and L were selected such that $akL/[\pi]^{1/2} \gg 1$ and $kL^2 \cos^2 \theta \ll \bar{D}$.

The first condition is required to match the theoretical and the experimental results, while the second condition is a hypothesis used in the derivation of the expressions for the angular spectra. Various trials lead us to assume that $h^2 \sim L^2 \sim 10^4 \text{ m}^2$. We then have the following equation for an approximate evaluation of the width of the angular spectra:

$$(1/2 + akL/2[\pi]^{1/2}) = (akL/[\pi]^{1/2} e^{-k^2 L^2 \tan^2 \varphi} (1 + \tan^2 \varphi))$$

By substituting the actual values we obtain:

$$\log 0.5 = -70 \times 10^{-4} \times 10^4 \times \tan^2 \varphi + \log(1 + \tan^2 \varphi).$$

or $\varphi = 4^\circ$

This value of four degrees for the width of the angular spectrum may be used in a first approximation as the wanted solution. The aperture is so small that the two angular spectra assume a shape similar to a delta function distribution. In such a case $p_y(0) \sim 2.1 p_x(0)$, and $p_y(0)$ and $p_x(0)$ can be interpreted as proportional to the received powers for propagation in the y and x directions.

Actually the absorption must be taken into account; therefore the expressions for the received powers become $\beta_y p_y(0)$ and $\beta_x p_x(0)$ where β_y is proportional to the absorption coefficient for y-propagation and β_x is proportional to the absorption coefficient for x-propagation.

The reduction of the angular spectra to a delta function shape is more acceptable when one recalls that a) the tails of the spectra correspond to much longer paths than the ones corresponding to the central parts, b) that these longer paths are in an absorbing region, and c) that the sensitivity of the receiving antennas decreases as we move away from the principal direction.

The application of the one-dimension corrugated reflecting surface to our case requires that the propagation in the y-direction coincides with E-W propagation and that the propagation in the x-direction coincides with S-N propagation. β_y and β_x may be deduced from Fig. 7. We can estimate that $\beta_y = 0.70$ and $\beta_x = 0.75$. Thus the corrugation will account for an increase of the signal from east over the signal from south to an amount of 1.96 in power ratio.

The increase in the observed E-W signal relative to the S-N signal has been computed from the records as follows:

The hourly median values of log microvolts input to the receiver have been scaled from the Esterline-Angus charts and are tabulated below for the equinoctial, winter and summer months in 1954-55.

From the following tables we have:

Table 4.4

	S-N path	E-W path
Winter average Nov-Feb 1954-55	115	82 microvolts
Equinoctial average Mar-Apr 1955	62	80.7 "
Summer average May-Aug 1955	65.6	32.9 "

Some kind of normalization has to be introduced. We proceed as indicated in the following:

Table 4.5

	S-N path	E-W path
Winter average	100	72.5 microvolts
Equinoctial average	100	130 "
Summer average	100	50.2 "
Winter-Summer average	100	61.4 "
Equinoctial average	100	130 "

TABLE 4.6

4240 kc

SHEEP MT. - COLLEGE

(HOURLY MEDIAN VALUES OF LOG MICROVOLTS INPUT)

- WINTER -

	00	01	02	03	04	05	06	07	08	09	10	11	12	13	14	15	16	17	18	19	20	21	22	23	24
Nov. '54	1.4	1.5	1.6	1.2	1.1	0.9	0.9	0.8	1.5	2.1	2.2	2.1	2.1	2.2	2.3	2.1	1.0	0.6	0.8	0.7	0.6	0.9	0.9	1.0	1.4
Dec. '54	1.3	1.3	1.4	1.2	1.1	0.9	1.0	1.0	1.2	2.2	2.4	2.4	2.5	2.6	2.6	1.8	0.8	0.7	0.6	0.7	0.9	1.0	1.1	1.2	1.3
Jan. '55	1.3	0.8	1.0	1.0	0.8	0.9	0.8	0.8	0.8	1.6	2.0	1.6	1.2	1.9	2.0	2.1	1.2	0.2	0.4	0.4	0.5	0.7	0.9	1.0	1.3
Feb. '55	1.5	1.6	1.5	1.0	0.8	0.9	0.8	0.7	1.5	1.9	1.7	1.6	1.8	2.1	2.2	2.2	2.3	1.9	0.9	0.5	0.5	0.8	1.0	1.4	1.5
Total	5.5	5.2	5.5	4.4	3.8	3.6	3.5	3.3	5.0	7.8	8.3	7.7	7.6	8.8	9.1	8.2	5.3	3.4	2.7	2.3	2.5	3.4	3.9	4.6	5.5
Average	1.38	1.30	1.38	1.10	0.95	0.90	0.88	0.82	1.25	1.95	2.08	1.92	1.90	2.20	2.28	2.05	1.32	0.85	0.68	0.58	0.62	0.85	0.98	1.15	1.38

TABLE 4.7 4240 kc SHEEP MT. - COLLECE (HOURLY MEDIAN VALUES OF LOG MICROVOLTS INPUT)
 - EQUINOCTIAL -

	00	01	02	03	04	05	06	07	08	09	10	11	12	13	14	15	16	17	18	19	20	21	22	23	24
Sep. '54	1.0	1.3	1.5	1.3	0.8	0.5	0.5	0.3	0.4	0.4	0.5	0.9	0.8	0.8	0.9	0.7	1.1	0.9	0.8	0.9	1.1	1.3	1.3	1.0	1.0
Oct. '54	1.1	1.5	1.2	1.0	0.7	0.7	0.7	1.0	1.6	1.8	1.8	2.0	1.7	2.1	2.0	1.8	1.6	2.1	0.9	0.7	0.9	0.9	0.8	1.0	1.1
Mar. '55	0.9	1.0	0.9	1.0	0.9	0.7	0.9	1.4	1.7	1.6	1.3	1.7	1.6	1.8	1.6	1.0	1.5	1.7	1.4	1.0	1.1	1.2	1.2	1.0	0.9
Apr. '55	1.2	1.3	1.6	1.3	0.8	1.0	1.3	1.2	1.7	1.8	2.0	2.1	2.2	2.1	2.2	2.1	2.2	2.2	2.0	1.8	1.1	1.6	1.6	1.2	1.2
Total	4.2	5.1	5.2	4.6	3.2	2.9	3.4	3.9	5.4	5.6	5.6	6.7	6.3	6.8	6.7	5.6	6.4	6.9	5.1	4.4	4.2	5.0	4.9	4.2	4.2
Average	1.05	1.28	1.30	1.15	0.80	0.72	0.85	0.98	1.35	1.40	1.40	1.68	1.58	1.70	1.68	1.40	1.60	1.72	1.28	1.10	1.05	1.25	1.22	1.05	1.05
Average March-April	1.05	1.15	1.25	1.15	0.85	0.85	1.10	1.30	1.70	1.70	1.65	1.90	1.90	1.95	1.90	1.65	1.85	1.95	1.70	1.40	1.10	1.40	1.40	1.10	1.05

TABLE 4.8

4240 kc SHEEP MT. - COLLEGE (HOURLY MEDIAN VALUES OF LOG MICROVOLTS INPUT)

- SUMMER -

	00	01	02	03	04	05	06	07	08	09	10	11	12	13	14	15	16	17	18	19	20	21	22	23	24
May '55	1.9	1.8	1.8	1.8	1.8	2.0	2.0	2.0	2.0	1.9	1.8	1.6	1.6	1.7	1.9	1.9	2.1	2.0	2.3	2.1	2.1	2.0	2.2	2.0	1.9
June '55	1.9	1.9	2.0	2.0	2.1	2.2	2.0	2.2	2.0	1.8	1.5	1.4	1.3	1.4	1.5	1.6	1.8	1.8	2.2	2.0	2.3	1.9	1.8	2.0	1.9
July '55	2.2	2.3	2.2	2.4	2.4	2.3	2.3	2.4	2.2	2.1	2.0	1.8	1.7	1.8	1.8	1.9	2.2	2.3	2.4	2.5	2.5	2.4	2.4	2.5	2.2
Aug. '55	2.2	2.0	2.1	1.9	1.8	2.1	2.1	2.2	2.4	2.3	2.2	2.1	1.9	2.0	2.1	2.3	2.3	2.3	2.4	2.4	2.6	2.2	2.2	2.1	2.2
Total	8.2	8.0	8.1	8.1	8.1	8.6	8.4	8.8	8.6	8.1	7.5	6.9	6.5	6.9	7.3	7.7	8.4	8.4	9.3	9.0	9.5	8.5	8.6	8.6	8.2
Average	2.05	2.00	2.02	2.02	2.02	2.15	2.10	2.20	2.15	2.02	1.88	1.72	1.62	1.72	1.82	1.92	2.10	2.10	2.32	2.25	2.38	2.12	2.15	2.15	2.05

TABLE 4.9 4095 kc NORTHWAY - COLLEGE (HOURLY MEDIAN VALUES OF LOG MICROVOLTS INPUT)
 - WINTER -

	00	01	02	03	04	05	06	07	08	09	10	11	12	13	14	15	16	17	18	19	20	21	22	23	24
Nov. '54	1.3	1.6	1.5	1.0	1.0	0.9	1.1	0.9	1.6	2.0	2.0	2.0	2.0	2.2	2.2	2.0	1.1	0.7	0.8	0.8	0.9	1.1	1.1	1.3	1.3
Dec. '54	1.4	1.7	1.4	1.2	1.2	1.0	1.0	1.1	1.5	2.4	2.4	2.4	2.4	2.6	2.4	1.8	0.8	0.5	0.6	0.6	0.8	0.9	1.2	1.5	1.4
Jan. '55	1.5	1.2	1.0	0.9	0.7	0.9	0.9	0.6	0.9	1.5	1.7	1.4	1.2	1.6	1.8	1.5	0.4	0.3	0.0	0.4	0.6	0.6	1.1	1.4	1.5
Feb. '55	1.7	1.8	1.2	1.2	1.0	0.8	0.8	1.0	2.1	1.7	1.4	1.6	1.4	1.8	2.0	2.2	2.4	2.0	1.0	0.5	0.6	0.8	1.7	1.8	1.7
Total	5.9	6.3	5.1	4.3	3.9	3.6	3.8	3.6	6.1	7.6	7.5	7.4	7.0	8.2	8.4	7.5	4.7	3.5	2.4	2.3	2.9	3.4	5.1	6.0	5.9
Average	1.48	1.58	1.28	1.08	0.98	0.90	0.95	0.90	1.52	1.90	1.88	1.85	1.75	2.05	2.10	1.88	1.18	0.88	0.60	0.58	0.72	0.85	1.28	1.50	1.48

TABLE 4.10 4095 kc NORTHWAY - COLLEGE (HOURLY MEDIAN VALUES OF LOG MICROVOLTS INPUT)
 - EQUINOCTIAL -

	00	01	02	03	04	05	06	07	08	09	10	11	12	13	14	15	16	17	18	19	20	21	22	23	24
Sept. '54	1.3	1.4	1.1	1.5	1.3	1.0	1.1	0.5	0.8	1.0	1.5	2.0	1.8	1.6	1.4	1.7	1.3	1.2	1.2	1.6	1.8	1.8	1.6	1.4	1.3
Oct. '54	1.5	1.3	1.1	1.1	0.8	0.7	0.8	0.9	1.4	1.7	1.7	1.7	1.7	1.6	1.5	1.5	1.7	1.7	1.4	1.4	1.4	1.2	1.3	1.4	1.5
Mar. '55	1.3	1.1	1.2	1.2	1.2	1.0	1.2	1.9	1.8	1.6	1.8	1.9	2.0	1.8	1.6	1.6	1.8	2.2	1.8	1.4	1.4	1.1	1.4	1.4	1.3
Apr. '55	1.5	1.1	1.4	1.3	1.0	1.4	1.6	1.7	2.0	2.0	2.1	2.0	1.9	2.0	2.0	2.4	2.3	2.0	2.1	2.0	2.0	2.2	2.0	1.6	1.5
Total	5.6	4.9	4.8	5.1	4.3	4.1	4.7	5.0	6.0	6.3	7.1	7.6	7.4	7.0	6.5	7.2	7.1	7.1	6.5	6.4	6.6	6.3	6.3	5.8	5.6
Average	1.40	1.22	1.20	1.28	1.08	1.02	1.18	1.25	1.50	1.57	1.78	1.90	1.85	1.75	1.62	1.80	1.78	1.78	1.62	1.60	1.65	1.58	1.58	1.45	1.40
Average March-April	1.40	1.10	1.30	1.25	1.10	1.20	1.40	1.80	1.90	1.80	1.95	1.95	1.95	1.90	1.80	2.0	2.05	2.10	1.95	1.70	1.70	1.65	1.70	1.50	1.40

TABLE 4.11 4095 kc NORTHWAY - COLLEGE (HOURLY MEDIAN VALUES OF LOG MICROVOLTS INPUT)
 - SUMMER -

	00	01	02	03	04	05	06	07	08	09	10	11	12	13	14	15	16	17	18	19	20	21	22	23	24
May '55	2.1	2.1	2.0	2.0	2.1	2.0	2.2	2.0	1.8	1.5	1.4	1.2	1.2	1.3	1.4	1.6	1.9	2.1	2.2	2.2	2.3	2.4	2.4	2.3	2.1
June '55	2.4	2.2	2.0	1.9	2.0	2.2	2.2	2.0	1.7	1.3	1.2	1.0	1.1	1.2	1.3	1.5	1.6	1.7	1.9	2.0	2.3	2.4	2.2	2.4	2.4
July '55	2.6	2.5	2.4	2.4	2.5	2.4	2.4	1.9	1.9	1.8	1.6	1.3	1.2	1.2	1.5	1.6	2.0	2.1	2.5	2.6	2.6	2.6	2.8	2.6	2.6
Aug. '55	2.5	2.3	2.4	2.2	2.2	2.3	2.4	2.4	2.3	2.1	1.9	2.4	1.8	1.8	1.9	2.2	2.4	2.4	2.8	2.6	2.7	2.7	2.7	2.4	2.5
Total	9.6	9.1	8.8	8.5	8.8	8.9	9.2	8.3	7.7	6.7	6.1	5.9	5.3	5.5	6.1	6.9	7.9	8.3	9.4	9.4	9.9	10.1	10.1	9.7	9.6
Average	2.40	2.28	2.20	2.12	2.20	2.22	2.30	2.08	1.92	1.68	1.52	1.48	1.32	1.38	1.52	1.72	1.98	2.08	2.35	2.35	2.48	2.52	2.52	2.42	2.40

Thus the recorded increase is of the order of $130/61.4 = 2.12$ in signal strength ratio equivalent to 4.49 in power ratio. We found before that the one-dimensional corrugation can account for an increase of the signal from east over the signal from south to an amount of 1.96 in power ratio.

Thus, the simple model of a surface corrugated in one dimension leads to a result which is in qualitative agreement with the observations but quantitatively insufficient. It could be argued that the difference between the estimated values for β_x and β_y is too large since these estimates for the absorption coefficients are based on 22 singular absorption events during March 1955. The difference between the average daytime absorption coefficients S-N and E-W for March-April 1955 would almost certainly come out somewhat smaller than that resulting from averaging the 22 singular events. A reduction of the difference between the two absorption coefficients would, other things being equal, lead to a better quantitative agreement between theory and observation. However, one also has to consider that the two paths for which signal strength observations are available were not perpendicular to each other as assumed in the theoretical calculation but intersected at an angle of approximately 60 degrees. Therefore, the decrease in the quantitative discrepancy which would result from reducing the difference between the absorption coefficients for the two paths would probably be at least outweighed by the increase in discrepancy resulting from turning the E-W path 30 degrees away from perpendicularity. The discrepancy of a factor of 2-2.5 in power must thus be accepted as indicating the inadequacy of the simple model of a reflecting surface corrugated in one dimension.

Since an effect in the right direction is obtained using this simple model, it is of interest to carry the investigation one step further and compute the variance of the signals received over the two paths. The theory of wave reflection from a surface corrugated in one dimension (Feinstein, loc. cit.) shows that the variance of

the received signal under normal conditions is

$$\sigma^2 = 1/2 \int \int dz \cos(2kvz/\nabla) \exp[-a[2-2\rho(z)-2\rho(v)+\rho(z-v)+\rho(z+v)]] \\ + \cos[2k(vz-z^2)/\nabla] \exp[-a[2-2\rho(z)+\rho(v)-2\rho(z+v)+\rho(2z+v)]] - 1]$$

where $v = x - x'$ and $\nabla = D/\cos^2 \theta$ for x-propagation

$\nabla = D$ for y-propagation

In a first approximation we have

$$\overline{(R^2)} - \overline{(R)}^2 = af$$

where $a = 4k^2 h^2 \cos^2 \theta$ is a measure of the height of the corrugations and

$$f = 1 + \frac{\sqrt{1 + \sqrt{1 + (8/u^2)^2}}}{\sqrt{2} \sqrt{1 + (8/u^2)^2}} - \frac{3\sqrt{1 + \sqrt{1 + (4/u^2)^2}}}{2\sqrt{2} \sqrt{1 + (4/u^2)^2}} - \frac{\sqrt{1 + \sqrt{1 + (12/u^2)^2}}}{2\sqrt{2} \sqrt{1 + (12/u^2)^2}}$$

with $u^2 = 2kL^2/\nabla$.

Then, for L small compared to the first Fresnel zone, we have

$$\sigma_x'^2 \sim a(1-0.38[2kL^2 \cos^2 \theta / \nabla])^{1/2} \quad \sigma_y'^2 \sim a(1-0.38[2kL^2/D])^{1/2}$$

Therefore different variances should be expected for the two directions of propagation. A measurement from the records would allow us to check first whether the anisotropy is present in the form we have postulated, and second whether the value estimated for a is acceptable.

At this point we must study the type of information the records contain with regard to the frequency spectrum of the incoming signal.

Under normal conditions the frequency spectrum is given by:

$$P_Q(\omega) = e^{-a} [\delta(\omega - \omega_0) + T_0 / [2\pi]]^{1/2} \cdot \sum_{n=1}^{\infty} (a^n / n! [n]^{1/2}) e^{-[(\omega - \omega_0)^2 / 2n] T_0}$$

where T_0 = fluctuation period. In a first approximation the frequency for the half power point will be given by the following equation:

$$1/2[1 + a + a^2/2[2]^{1/2}] = [(1 + a)s^2 + a^2s/2[2]^{1/2}]$$

with $s = \exp[-(\omega - \omega_0)^2 T_0^2 / 4]$.

To solve for s a knowledge of T_0 is required. The backscatter soundings at 12 mc/s from College has shown that the fading rate for groundscatter propagated via the F-layer is of the order of 1 to 2 cycles per second while the fading rates for sporadic E propagated groundscatter and direct backscatter echoes from Es patches are between 4 and 8 cycles per second⁶. Considering the beamwidth of the antennas and the frequency dependence of the fading rate a value of T_0 approximately equal to 2 seconds represents a reasonable estimate. In a recent paper on turbulence in the ionosphere Booker⁷ has derived a time constant of 2 seconds for the small eddies at 110 km height. This figure for T_0 may now be used to obtain a rough idea of the frequency spectrum of the received signals.

Solving the above equation for s with $a = 70$ meters and $T_0 = 2$ seconds we obtain,

$$71 s^2 + 1750 s - 910 = 0 \quad s = 0.49$$

$$\omega - \omega_0 = 0.56 \text{ rad/sec} \quad f = 0.1 \text{ cycle/sec.}$$

It follows that a record to be useful for the calculation of σ^2 should give information on the frequency spectrum components up to the order of 6 cycles per minute. This is unfortunately not the case for the Task A charts which were run at a speed of 1 1/2 inch per hour. The frequency spectrum is readable only up to components of the order of 1/5 cycles per minute. This limitation is quite serious when one considers that the tails of a distribution give an essential contribution to the value of σ^2 .

Another difficulty is that apparently the intense and fast fluctuations recorded may be due to interference. Indeed the signal levels generally decrease and increase simultaneously on both the records for E-W and S-N paths.

Furthermore the slow components of the fluctuations on both paths are masked by changes in amplitude due to absorption. Finally it must be remembered that, on account of the finite apertures of the transmitting and receiving antennas, not all the information assumed in the theoretical approach is available. Consequently, the variance cannot be derived from the Task A records, and further experimental testing of the theory is not possible.

At this point it is appropriate to summarize the position.

(1) We have found that the simple model of a reflecting surface corrugated in one dimension together with the measured absorption gives a qualitative, but not a satisfactory quantitative agreement, of the observed difference in the received signal strength over the short 4 mc/s E-W and S-N paths during the spring equinox of 1955. The theoretically derived difference in the variance of the frequency spectra for the two paths cannot be checked against the observations because of shortcomings of the recorded data.

(2) The corrugation required to obtain the qualitative agreement between theory and experiment must be aligned in the E-W direction if the simple model may be assumed to represent a first, rough approximation to actual conditions. That is, the theory discussed above requires that there are striations in the electron density distribution along parallels to the auroral zone.

(3) The last conclusion is disturbing from the theoretical point of view because we would like to believe that a theory of forward scattering by spheroidal blobs aligned with the earth's magnetic lines of force together with absorption will explain fully the experimental situation. Field-aligned spheroidal blobs would tend to introduce

elliptical corrugations in the reflecting layer whose major axis are aligned in the magnetic meridian, not at right angles to it. If the conclusion reached in (2) is correct, the combination of the fine-structure introduced by the field-aligned spheroidal blobs and absorption is insufficient to explain the observations, and an additional fine-structure consisting of striations along the auroral zone must be postulated. It is therefore important to study other simplified models which will introduce corrugations at right angles to the auroral zone. This should make it possible to judge if the presence of field-aligned spheroidal blobs would be sufficient to explain the observations, or the additional striations along the auroral zone must indeed be invoked.

The second model selected for study is shown in Fig. 10. It consists of a plane reflecting screen with a grating of mutually parallel circular cylinders located a distance, d , apart and the same distance from the reflecting surface. Each cylinder has a diameter of $2r$ and is assumed to be of infinite length. We shall limit the discussion to a particular case defined by the conditions:

$$kr < 0.2 \quad d > \lambda/2\pi \quad \left(= \frac{1}{k} \right)$$

The problem of finding the reflection coefficient for oblique incidence in the x and y direction with horizontal polarization is a difficult one. We shall satisfy ourselves with a first order approximation leading to the following simplifications:

- 1) The field received and reradiated by the cylindrical elements is practically undisturbed by the presence of the other elements.
- 2) The polar diagram of the scattering coefficient for parallel electrical polarization in a plane normal to the axis of the cylinders is roughly circular.
- 3) The scattering coefficient for transverse electric polarization in a direction normal to the axis of the cylinders is the same for backward and forward propagation.

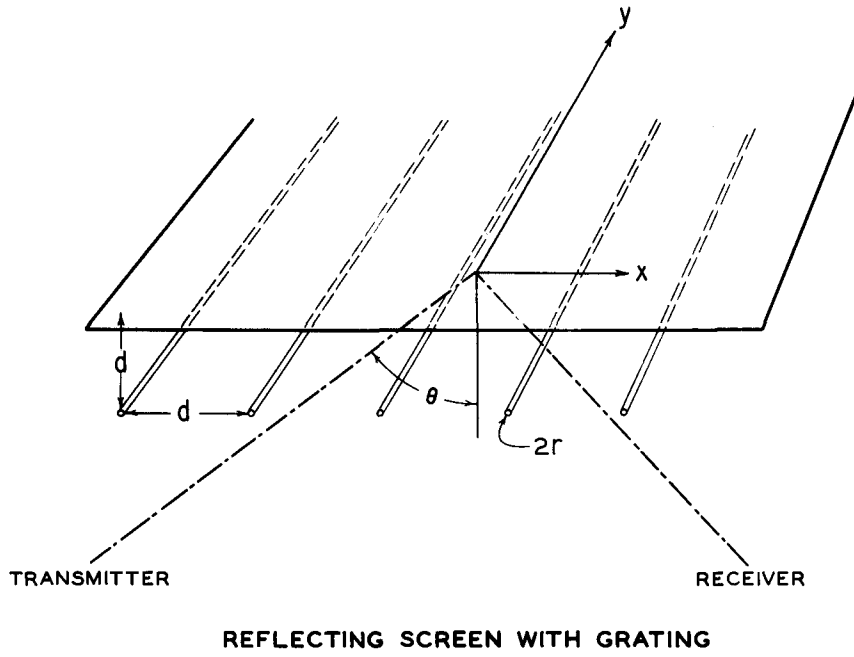

Fig. 10

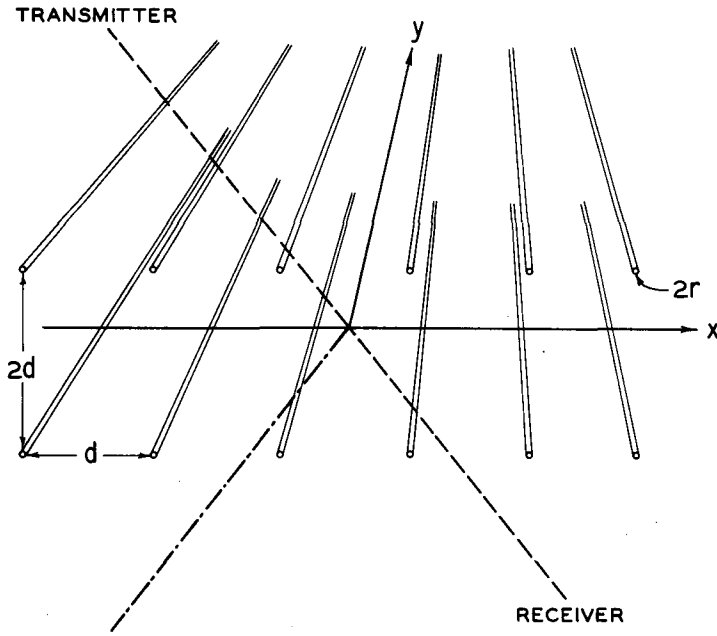

Fig. 11

4) The amplitude for propagation parallel to the axis of the cylinders is proportional to $\sec \theta$, where θ is the angle of specular reflection on the reflecting screen.

These four points require some comment and justification. The lack of interaction between the cylinders themselves as well as between the cylinders and the reflecting screen can be accepted on account of the condition $d > \frac{\lambda}{2\pi}$ since the induction component of the field that surrounds an antenna decreases according to $(1/kr)^2$ against the law $1/kr$ that is valid for the radiation terms. The polar diagram of the parallel scattering coefficient in a plane normal to the axis of the small cylinders is roughly circular when the condition $kr < 0.2$ is imposed (cf. Keitel⁸.)

Again when $kr < 0.2$ the scattering coefficient for transverse electric polarization in a direction normal to the axis of the cylinders is the same for backward and forward propagation (Keitel, loc. cit.). Condition 4 is simply an application of the shift-rules which hold for angular spectra, used twice: "If the angular spectrum $P(S)$ corresponds to the aperture distribution $E_y(0,y)$, then $P(S-S_0)$ corresponds to $E_y(0,y)\exp(-jkSy)$ ".

Thus the four conditions are implicitly contained in the two basic conditions $kr < 0.2$ and $d > \frac{\lambda}{2\pi}$. They introduce a symmetry with respect to the reflecting screen which permit the application of the method of images to the solution of our problem. The situation illustrated in Fig. 10, then becomes equivalent to the situation depicted in Fig. 11.

It will be seen that in the present case, the contribution to the received signal strength from cylinders located off the principal direction from transmitter to receiver, is larger for parallel than for transverse polarization. This is opposite to the situation for a corrugated reflecting screen.

The theory of scattering of radio waves from a single metallic cylinder has been considered by many writers. We shall follow the treatment presented by Feinstein⁹.

The following table for the reflection coefficients for parallel polarization (R_p) and transverse polarization (R_T) as a function of effective cylinder size (kr) is based on one of the diagrams in Feinsein's paper (loc. cit., Fig. 2).

Table 4.12. Reflection Coefficients

kr	R_p	R_T
1.0	0.95	0.90
0.8	0.87	0.78
0.6	0.77	0.61
0.4	0.70	0.49
0.2	0.60	0.095
0.1	0.52	0.024

The reflection coefficient for $kr < 0.2$ therefore differs by a factor larger than 5 for parallel and transverse polarization. On account of the conditions 2 and 3 the same is true for the scattering coefficients for parallel and transverse polarization. In our case we have $\sec \theta \sim 2$. Taking into account the 4th condition listed above, we arrive at the conclusion that propagation in a direction transverse to the grating should produce a signal at the receiver site which is at least 2.5 times greater than the signal propagated in a direction parallel to the grating. This exceeds the observed difference in the received signals over the short 4 mc/s E-W and S-N paths during March 1955 which was found to amount to a factor of about 2.

We conclude that a physical mechanism whose effect on the incident waves can be approximated in a rough way by the second model together with absorption should be capable of explaining the observed differences in the strength of the signals propagated over the short 4 mc/s E-W and S-N paths. Therefore a theory of forward scattering of radio waves by field-aligned spheroidal blobs may well prove adequate, and

introduction of additional striations parallel to the auroral zone unnecessary. It may be noted that a start towards the mathematical theory of radio wave scattering in ionospheric spheroidal blobs are contained in relatively recent investigations by Schultz¹⁰ and Rauch¹¹.

REFERENCES

1. Interim Scientific Report No. 1 Tasks A, B and E (Quarterly Progress Report No. 4), 1955. Contract No. DA-36-039 SC-56739. (Abbreviated: ISR 1955).
2. Final Report, Task A and B, 1956. Contract No. DA-36-039 SC-56739. (Abbreviated: FR 1956).
3. C. G. Little and H. Leinbach, Proc. I.R.E., 46, 334, 1958.
4. S. P. Gosh, Ind. Jour. Phys., 12, 341, 1938.
5. J. Feinstein, Trans. I.R.E., AP-2, No. 1, 23, 1954.
6. L. Owren and R. A. Stark, Final Report, Task B, 1957. Contract No. DA-36-039 SC-71137.
7. H. G. Booker, J. Geophys. Res., 61, 673, 1956.
8. G. H. Keitel, Proc. I.R.E., 43, 1481, 1955.
9. J. Feinstein, J. Geophys. Res., 56, 37, 1951.
10. F. V. Schultz, UMM-42, Project MX-794, Contract No. AF W038-ac-14222, University of Michigan 1953.
11. L. M. Rauch, UMM-116, Project MIRO, Contract No. AF 30(602)-9, University of Michigan 1953. (See also: K. M. Siegel, F. V. Schultz, B. H. Gere, and F. B. Sleator, Trans. I.R.E., AP-4, No. 3, 266, 1956.)

5. F2 Region Parameters at College for the Period June 1941 through December 1956.
(C. G. Little)

Since June 1941, systematic recordings of the virtual heights and critical frequencies of the various ionospheric layers over College have been made using sweep-frequency ionospheric sounders. The curves of Figs. 12 through 15 summarize some of the F2 region data obtained in this manner.

Fig. 12A and 12B give the monthly median midnight and noon values of the vertical incidence critical frequency of the F2 layer for the 15 1/2 year period. The effect of the sunspot cycle upon the critical frequency is readily apparent in both the midnight and midday values. The annual median critical frequencies increase from about 2.5 mc (midnight) and 4.2 mc (noon) during sunspot minimum years to about 4.0 mc (midnight) and 8.0 mc (noon) during the 1947-49 sunspot maximum years.

The marked change in the seasonal variation of noon f_oF2 values with the sunspot cycle is also of interest. During the sunspot minimum years, there is no significant seasonal variation in the noon f_oF2 values, even though the midday solar zenith angle ranges from about 52 degrees to about 87 degrees during the year. In sunspot maximum years, a marked seasonal variation appears in both the midnight and the noon values. The seasonal variations of these two values are actually in antiphase, since the midnight values maximize during the summer and the noon values during the winter. These contrasting seasonal variations result in marked differences between the diurnal variations in summer and winter. During the summer months (Fig. 13A) there is very little diurnal variation, but for the winter months, particularly in sunspot maximum years, a marked daytime peak in f_oF2 is obtained (Fig. 13B).

While the f_oF2 data presented in Figs. 12 and 13 could be duplicated for other hours of the day or other months of the year, this does not seem necessary, since they do include sufficient information on the diurnal, seasonal and sunspot cycle

A

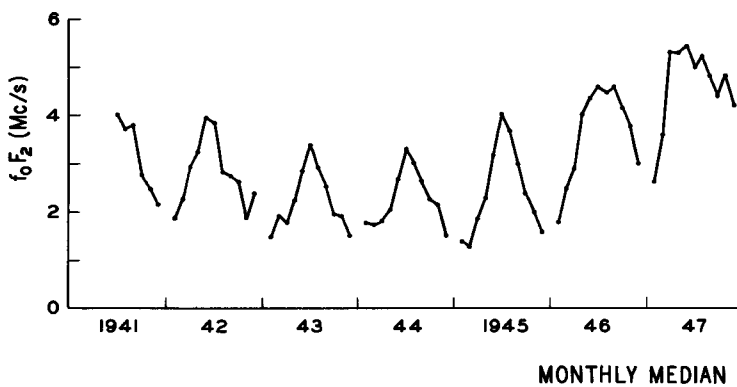

B

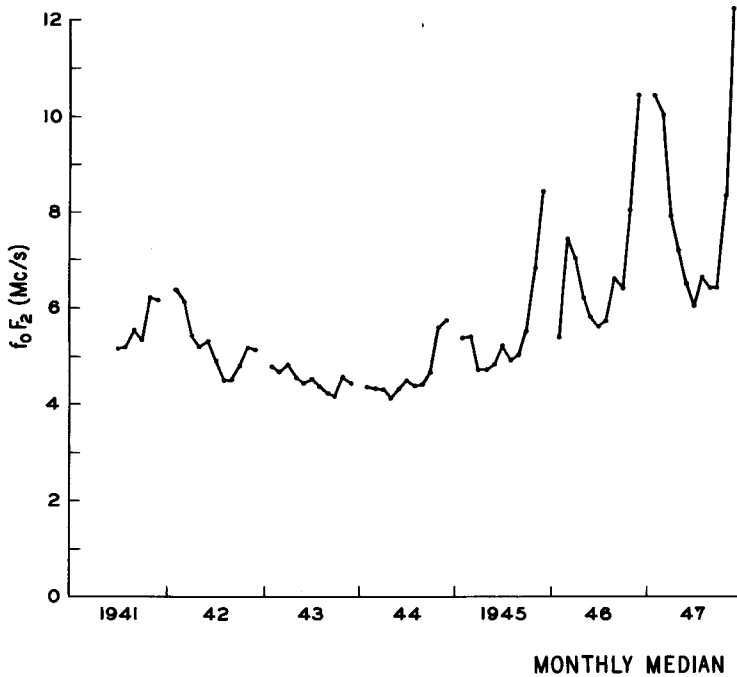

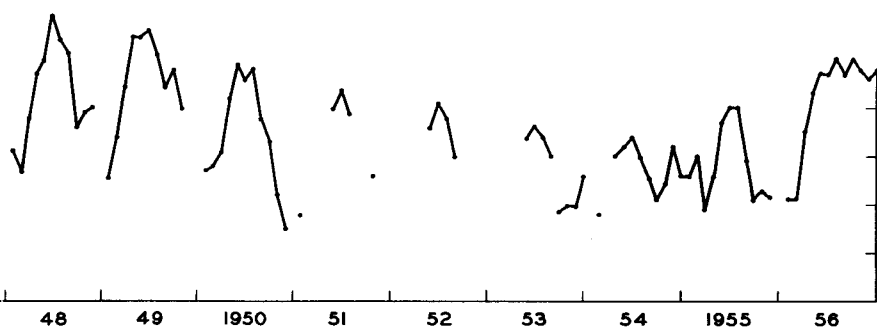

f_0F_2 AT COLLEGE AT MIDNIGHT A.S.T.

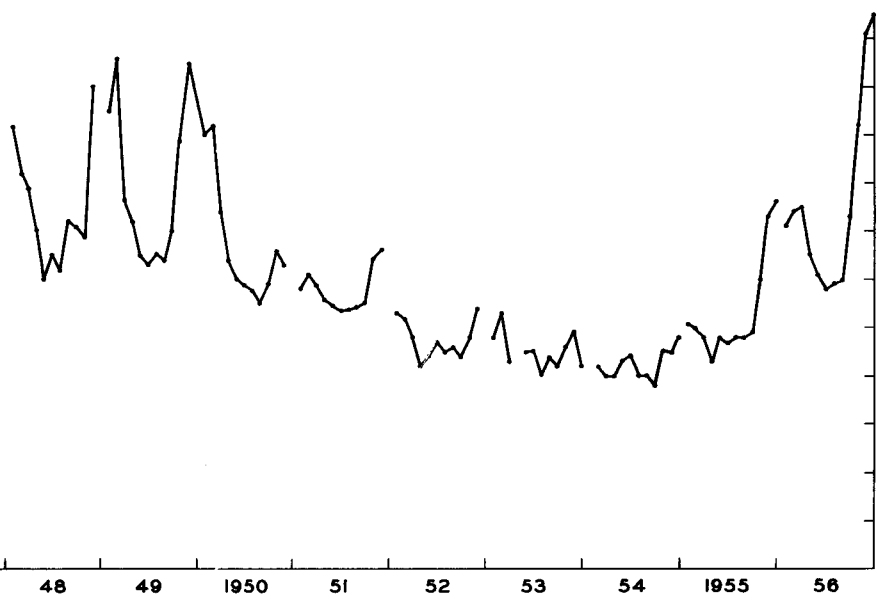

f_0F_2 AT COLLEGE AT 1200 A.S.T.

Fig. 12

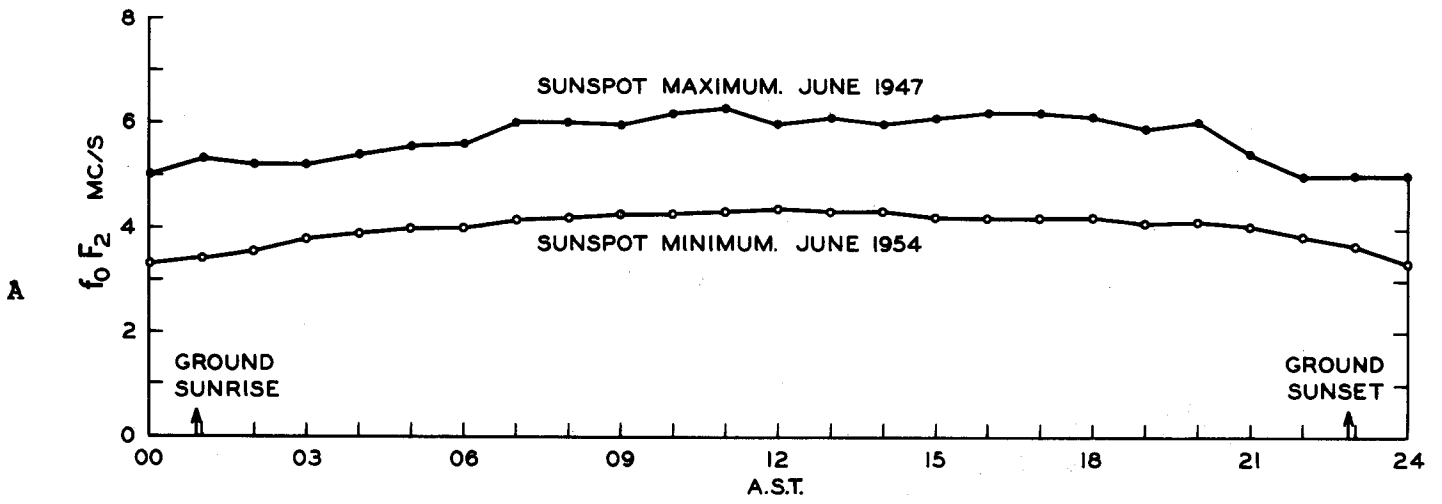

DAILY VARIATION OF f_0F_2 AT COLLEGE DURING JUNE

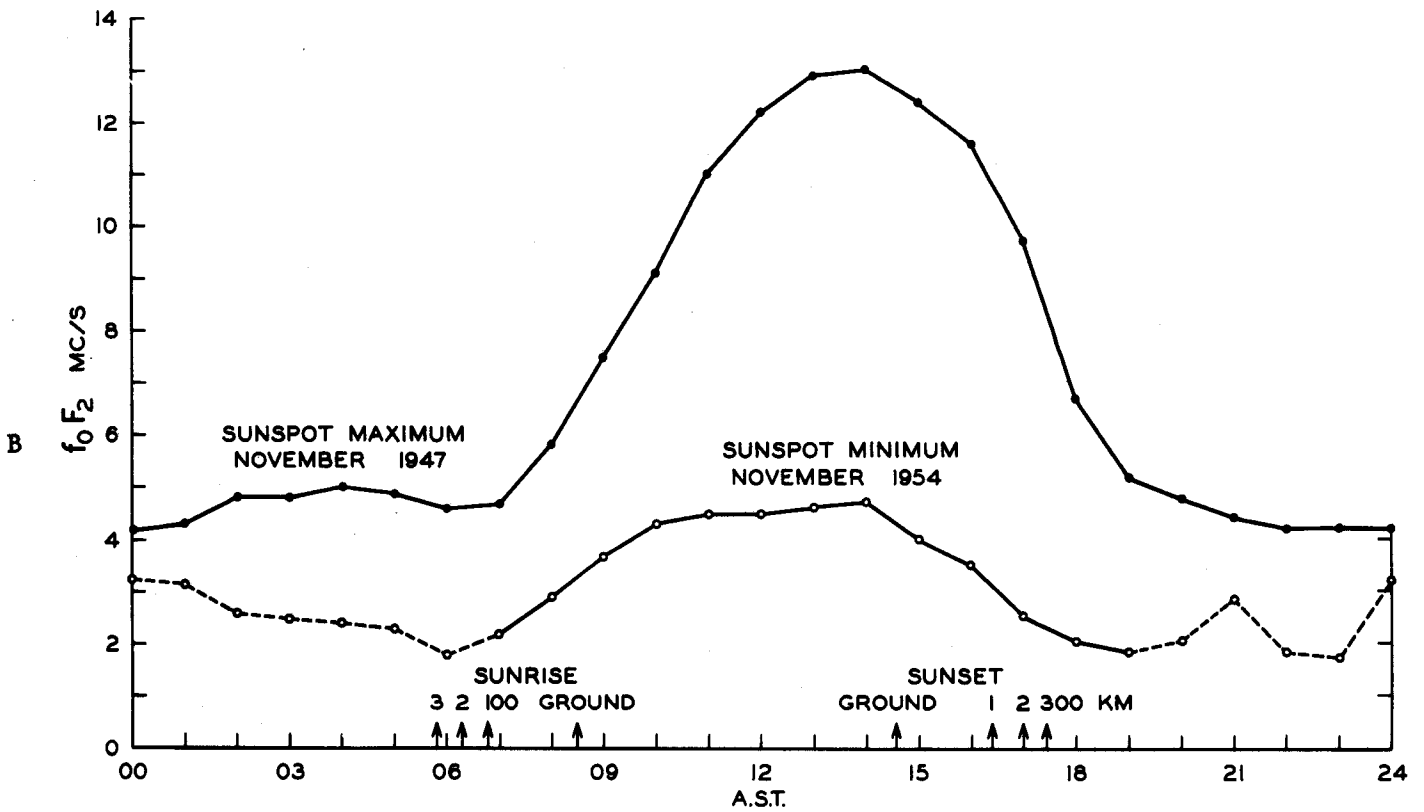

DAILY VARIATION OF f_0F_2 AT COLLEGE DURING NOVEMBER

Fig. 13

dependence of f_oF2 at College, to permit rough estimates to be made of the critical frequency at any hour or month or position in the sunspot cycle.

A similar series of graphs giving the temporal variations of the virtual height of the F2 layer are given in Figs. 14 and 15. The values plotted are monthly median values of the minimum virtual height at which echoes were obtained from the F2 region. During winter months, or in the hours of darkness, these heights will be closely equal to the true height of the bottom of the F2 region. The non-winter observations taken during daylight hours will tend to give virtual heights significantly greater than the true heights of the bottom of the layer, owing to retardation effects in the F1 layer.

It will be seen that the midnight monthly median values of $h'F2$ show relatively little seasonal variation whereas the noon values show a marked maximum of $h'F2$ during the summer months. This feature, combined with the surprisingly low f_oF2 values observed during the summer months, is consistent with the idea that the F2 region is grossly distended during the summer months. The very large electron densities observed during sunspot maxima winter daytimes ($f_oF2 = 12$ mc or higher) are presumably due to a relatively thin F region containing less total number of electrons than the thick summer layer¹. The reasons for this apparent change in the shape of the F2 region from summer to winter, and for the change in seasonal variation of f_oF2 with mean sunspot number are not known. It is clear that these phenomena are systematically present in the College data, and that they will have to be explained before a full understanding of F region propagation at auroral latitudes can be reached.

REFERENCE:

1. Ratcliffe, J. A., J. Geophys. Res. 56, 463 (1951) and 56, 487 (1951).

A

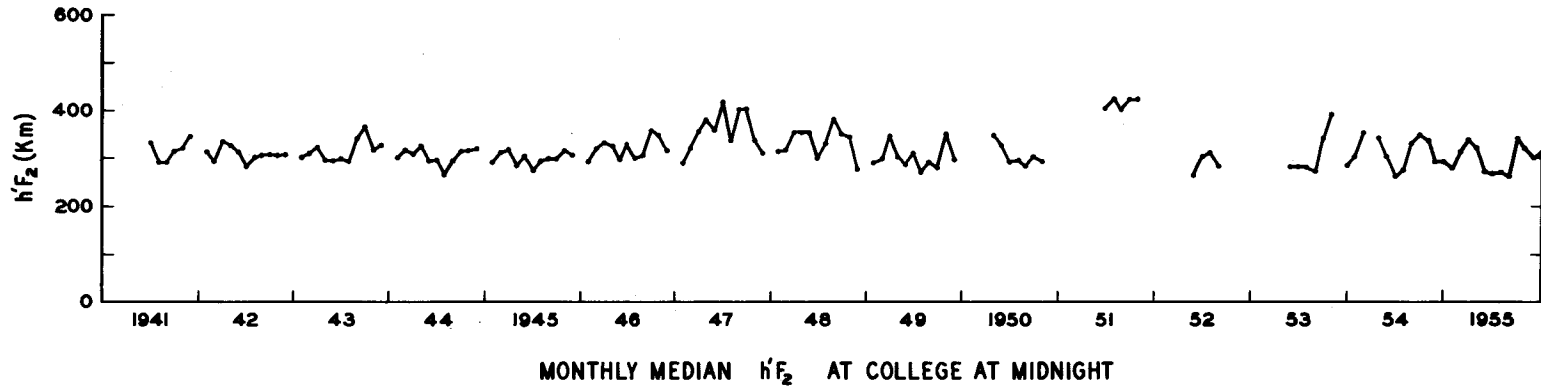

B

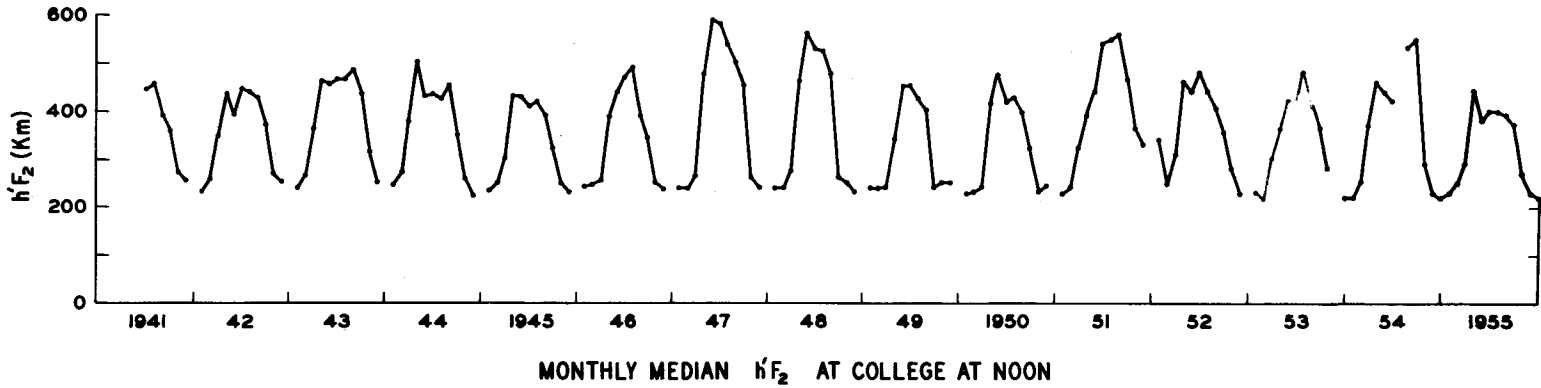
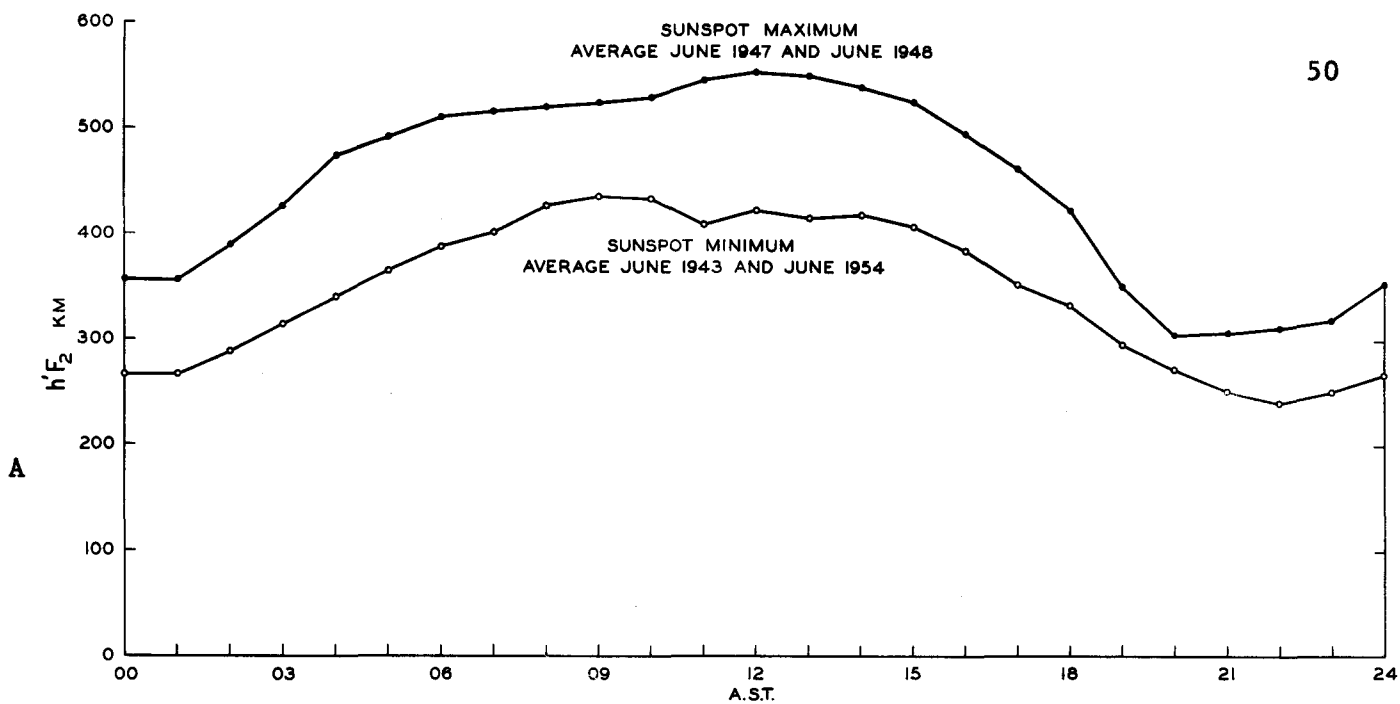
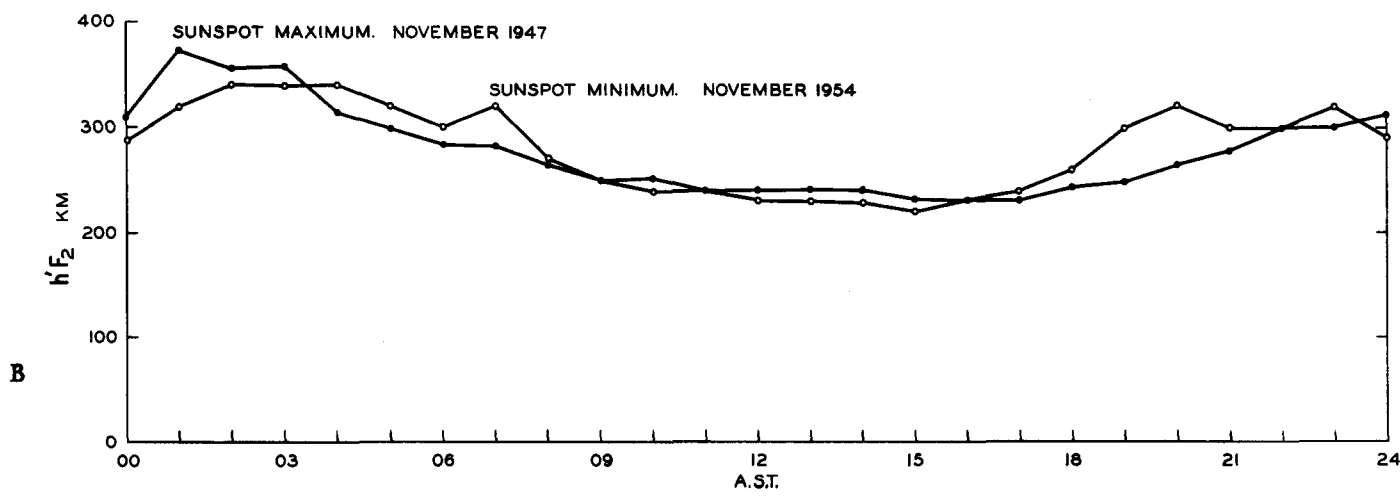

Fig. 14



DAILY VARIATION OF h'F₂ AT COLLEGE DURING JUNE



DAILY VARIATION OF h'F₂ AT COLLEGE DURING NOVEMBER

Fig. 15

6. Tables of Monthly Medians of Median Signal Strength June 1949 - December 1950 and January 1954 - October 1955. (L. Owren)

In course of the analyses of the transmission data secured during "Experiment Aurora" considerable use has been made of the monthly medians of the hourly median signal strength scaled in units of log microvolts. Such monthly medians formed the basis for investigations contained in Interim Scientific Report No. 1, (Quarterly Progress Report No. 4), Tasks A, B and E, 1955, Contract No. DA-36-039 SC-56739; Final Report, Task A and B, 1956, Contract No. DA-36-039 SC-56739; and Sections 2 and 4 of the present report. The periods June 1949 - December 1950 and January 1954 - October 1955 have been of most importance in this connection. The following pages contain tables of the monthly median values of the hourly median received signal strengths (measured in log microvolts) for all paths and frequencies during the two periods mentioned. It would have been desirable to include a complete set of tables covering all of the 76 months (June 1949 - October 1955) during which the "Experiment Aurora" transmissions took place, but for reasons of cost and space the tables have been limited to the two periods for which significant use has been made of the data. This is justified by the fact that the contractor already has received a complete set of copies of the tabulations of hourly and monthly median signal strengths.

During one of the studies involving the monthly medians it was felt that the original tabulations were somewhat biased in favor of the higher values because the rejection criteria applied to signals near the limit of detectability were unnecessarily restrictive. This also in some instances impaired the statistical significance of the monthly median values. Finally, re-examination of the basic scalings of the hourly median values from the Esterline-Angus charts showed that actual errors in scaling had been committed by one particular scaler in connection with the earliest recordings. Consequently, it was decided to rescale early records and spot-check the later records for scaling errors. Also, a new set of criteria were set

up for forming the monthly medians and applied to the 1949-50 and 1954 listings of hourly median values of signal strength. Subsequent study of the effect of the revised criteria on the monthly median values showed that the difference between the original values and the revised values was not significant, particularly in the last years of the transmission experiment. Therefore a re-evaluation of the monthly medians for the period January - October 1955 was deemed unnecessary, and the original values are listed in the tables. We note in particular that the results of the studies carried out with the original values of the monthly medians, such as the ones contained in the Interim Scientific Report of 1955, remain valid.

The instructions for scaling the hourly median value of signal strength are given below in the form used during "Experiment Aurora". These instructions include under "Median Count" the original criteria for inclusion and exclusion of values in taking the monthly median. The "Scaling Instructions" are followed by a listing of the revised instructions applied to the 1949-50 and 1954 data. The "tags" mentioned refer to the 4-5 minute "signal off" periods of the transmitter occurring every 20 minutes during which interval a morse code identification was made.

SCALING INSTRUCTIONS

1. Record values on the traces.
2. When no tags are present or the median value of the tag is within 0.3 microvolts of the median value of the signal, Scale as "E".
3. When tags are present and the median value of the signal is below the lowest calibration. Scale as " $<$ ".
4. When no tags are present and the median value of the signal is below the lowest calibration. Scale as "E".

5. To be written in symbol key:

X(N): Median value of noise or interference level is less than the minimum scalable value of (N) log microvolts. (N = lowest calibration value).

6. Where "C" is present for part of an hour:

a. Upper left hand corner - time on

example: 3 C on for first 30 minutes

1.25 median value for remaining 30 minutes

b. Upper right hand corner - time off

example: C 2 off for first 20 minutes

1.25 median value for rest of hour

c. No "E" is used unless interference occurs for more than 30 minutes. This applies to hours containing "C" time, also.

7. The scaler should place her initials where the station and frequency is stamped.

8. When only one tag is present the value is automatically "E".

9. When three tags are present the middle tag is the one used for scaling.

10. When only two tags are present the mean of the two is used.

Median Count:

All signal intensity values are counted except:

1. When the difference between noise-plus-signal level and noise level is 0.3 log microvolts or less.
2. C = over 30 minutes of the hour.
3. All "<" values = when tags are present and the median value of the signal is below the lowest calibration.

Median is doubtful when:

1. Count is equal to or greater than 5 and equal to or less than 9.
2. When the count is equal to or less than 4, no median is taken.

REVISED INSTRUCTIONS FOR DETERMINATION OF MEDIANS

1. Omit all numbers or spaces identified by E, C, S, or ().
2. Record for entries of $\ll -0.5$ or E_{-0} or $E \ll -0.5$: -1
3. Record for X (when consistent with the significance of X as usually given at the bottom of the sheet) : -1
4. Record for square brackets : the number enclosed.

The tabulation sheet used for the hourly median signal strength was CRPL Form 1-3 "Field Intensity Data". The monthly median value for each hourly interval was entered at the bottom together with the count (number of hourly values included). Space limitations prevented inclusion of the actual count in the tables below. Instead the range of the count is indicated as follows:

Counts between 1 and 10	:	The entry is marked with the symbol #
Counts between 11 and 20	:	The entry is marked with the symbol *
Counts between 21 and 31	:	The entry is unmarked.

Uncertain values are entered in parenthesis: (), and no entry is indicated by a hyphen: - , or by a blank space. The entries denote the monthly median value in log microvolts for the indicated hourly interval.

Space considerations made it necessary to arrange the tables by 13 month intervals. Therefore, for each path and frequency, the tabulations for the period July 1949 - December 1950 are followed by the tabulations for the period January 1954 - June 1955, and the remaining entries for June 1949 and the period July - October 1955 are grouped together in a supplementary table.

It may be noted that the transmitting frequency over a given path in some instances was changed slightly during the experiment. In such cases, this is indicated in the heading of the table.

The transmitters for the South-North path were located in Anchorage during the period June 1949 - June 1951 and then moved to Sheep Mountain where they operated during the remainder of the transmission experiment (terminated 20 October 1955).

The tables are otherwise self-explanatory.

TABLE 6.1

MONTHLY MEDIAN

	1949						1950	
	Jul	Aug	Sep	Oct	Nov	Dec	Jan	Feb
00-01	0.55	0.3	-0.4	-1.00	-1.00	0.05*	1.90	1.15
01-02	0.65	-0.2	-0.4	-1.00	-1.00	0.10*	1.40	1.20
02-03	0.45	0.0	-1.00	-1.00	-1.00	0.05*	1.30	1.00
03-04	0.30	-0.3	-0.2	-1.00	-1.00	0.20*	1.50	1.00
04-05	0.4	-1.00	-0.3	-1.00	-1.00	0.00*	1.60	1.10
05-06	0.1	-1.00	-0.55	-1.00	-1.00	0.05*	1.60	0.85
06-07	-0.1	-0.4	-0.4	-1.00	-1.00	0.25*	1.00	1.30
07-08	-0.15	-0.4	-0.35	-1.00	-1.00	-0.20*	0.70	1.25
08-09	-0.5	-1.00	-1.00	-1.00	-1.00	0.35*	1.30	1.00
09-10	-1.00	-1.00	-1.00	-1.00	-1.00	0.05*	1.80	0.65
10-11	-1.00	-1.00	-1.00	-1.00	-1.00	-0.10*	1.15	0.20
11-12	-1.00	-1.00	-1.00	-1.00	-1.00	-0.30*	0.90	0.40
12-13	-1.00	-1.00	-1.00	-1.00	-1.00	-0.20*	0.95	0.50
13-14	-0.55	-1.00	-1.00	-1.00	-1.00	0.00*	1.35	0.80
14-15	-0.55	-1.00	-1.00	-1.00	-0.1	0.20*	1.55	0.80
15-16	-0.4	-1.00	-1.00	-0.3	0.0	0.20*	1.95	0.65
16-17	-0.3	-1.00	-0.4	-0.35	-0.25	0.30*	2.05	1.20
17-18	-0.25	-0.30	-0.3	0.0	0.2	0.35*	2.05	1.40
18-19	0.25	-0.2	0.2	-0.2	0.35	0.35*	1.2	1.65
19-20	0.35	-0.2	0.4	-0.1	0.20	-0.05*	1.70	1.70
20-21	0.4	0.10	0.1	0.1	0.20	-0.20*	1.70	1.50
21-22	0.4	0.20	-0.1	0.2	-0.15	0.20*	1.80	1.20
22-23	0.45	0.3	-0.1	-0.25	-0.20	0.20*	1.30	1.00
23-24	0.70	0.3	-0.35	-0.4	-1.00	0.30*	2.00	1.00

Count between: 0-10

* Count between: 11-20

() Uncertain Value

Count between 21-31 - No indication

NORTHWAY - COLLEGE

4 mc

4095 kc Short Path E-W

Mar	Apr	May	Jun	Jul	Aug	Sep	Oct	Nov	Dec
1.10	1.20	1.30	1.70	1.90	1.80	1.35	1.00	0.30	1.00
1.20	0.60	0.80	1.65	1.65	1.65	1.10	0.45	0.50	1.00
1.00	0.30	0.60	2.00	1.30	1.80	0.70	0.80	0.60	0.80
0.80	0.50	0.50	2.10	1.60	1.70	0.65	0.90	0.30	0.60
1.10	0.40	0.90	2.20	1.90	1.70	0.80	0.90	0.40	0.70
1.30	0.40	0.60	2.10	2.00	1.30	0.70	0.80	0.30	0.40
1.00	0.50	0.10	1.70	1.70	1.20	0.85	-0.55	0.30	0.50
1.00	0.60	-0.10	1.35	1.40	1.15	1.20	-0.35	0.00	0.85
0.85	0.40	-1.00	1.00	1.30	0.60	1.20	0.55	0.80	1.20
0.80	-0.55	0.00	1.00	1.10	0.40	0.10	-0.10	0.50	1.20
0.50	-1.00	-0.10	1.00	0.90	0.50	-1.00	-0.30	0.45	1.00
0.60	-1.00	-1.00	1.00	0.90	0.50	0.00	0.00	0.30	1.00
0.90	-1.00	0.0	1.05	0.80	0.50	-0.10	0.30	-0.10	1.25
1.00	-1.00	-0.2	1.00	1.10	0.45	0.50	0.15	0.20	1.60
1.30	0.0	-1.00	0.80	0.90	0.65	0.40	0.70	0.60	1.60
1.30	0.20	0.10	0.90	1.20	0.95	1.15	1.10	0.80	1.60
1.30	0.50	0.50	1.10	1.50	1.25	1.10	1.20	0.70	1.50
1.20	1.10	1.00	1.50	1.70	1.50	1.45	1.00	0.90	1.00
1.40	1.00	1.40	1.70	2.00	1.80	1.65	1.40	0.90	0.80
1.60	1.40	1.70	1.90	2.00	1.90	1.80	1.40	1.00	1.00
1.60	1.40	1.65	2.20	2.30	2.00	1.70	1.20	0.90	1.15
1.10	1.30	1.70	2.45	2.40	2.00	1.30	1.20	1.00	1.35
1.10	1.30	1.55	2.30	2.50	1.90	1.30	1.20	0.80	1.35
1.00	1.40	1.60	2.35	2.25	1.90	1.10	0.65	0.60	1.00

TABLE 6.2

MONTHLY MEDIAN

1954

	Jan	Feb	Mar	Apr	May	Jun	Jul	Aug	Sep
00-01	.90	0.55	0.4	0.85	1.20	1.70	1.50	1.60	1.1
01-02	.80	0.40	0.3	0.75	1.60	1.70	1.20	1.45	1.4
02-03	0.85	0.4	0.2	0.80	1.40	1.8	1.00	1.50	1.1
03-04	0.90	-0.2	0.2	0.6	1.40	1.70	1.00	1.15	1.4
04-05	0.7	0.4	0.1	0.6	1.30	1.70	1.00	1.00	.70
05-06	0.6	-0.15*	0.1	0.7	1.30	1.60	1.20	1.20	.25
06-07	0.45	-0.2 *	0.05*	0.6	1.50	1.75	1.40	1.15	.30
07-08	0.4	0.2 *	0.2 *	0.45	1.50	1.60	1.60	1.10	.10
08-09	0.6	0.45*	0.2 *	0.65	1.40	1.40	1.40	1.50	.35
09-10	1.00	0.9 *	0.7 *	0.80	1.30	1.40	1.20	1.60	.70
10-11	1.35	0.55*	0.6 *	1.1	1.10	1.20	1.10	1.20	1.2
11-12	1.4	0.7 *	0.5 *	0.8	1.10	1.1	1.00	1.45	1.5
12-13	1.4	0.75*	0.4 *	0.9	0.95	1.1	1.00	1.60	1.5
13-14	1.2	0.8 *	0.8 *	0.9	1.10	1.1	1.00	1.80	1.4
14-15	1.4	1.3 *	0.5 *	1.0	1.30	1.20	1.10	1.60	.80
15-16	1.4	0.7 *	0.6	0.6	1.30	1.40	1.40	1.55	1.4
16-17	0.20	1.1 *	0.2 *	0.8	1.60	1.70	1.40	1.40	.80
17-18	0.0	0.25*	0.3	0.65	1.50	1.60	1.50	1.10	.90
18-19	0.0	-0.35*	0.0	0.9	1.30	1.70	1.30	1.10	.80
19-20	0.0	-0.1	0.15	0.75	1.40	1.30	1.50	1.30	1.45
20-21	0.15	.10	0.3	0.9	1.50	1.80	1.40	1.30	1.70
21-22	0.3	0.5	0.5	0.6	1.30	1.80	1.40	1.40	1.70
22-23	0.6	0.55	0.5	0.7	1.40	1.80	1.30	1.40	1.4
23-24	0.65	1.0	0.45	0.8	1.30	1.70	1.50	1.60	1.4

NORTHWAY-COLLEGE

4 mc

4095 kc

Short Path E-W

1955

Oct	Nov	Dec	Jan	Feb	Mar	Apr	May	Jun
1.2	1.25	1.40	1.5	1.7	1.3	1.5*	2.1	2.4
1.3	1.5	1.70	1.2	1.8	1.1	1.1*	2.1	2.2*
1.0	1.45	1.4	1.0	1.2	1.2	1.4	2.0	2.0*
1.1	1.10	1.2	0.9	1.2	1.2	1.3	2.0	1.9
0.8	1.0	1.2	0.7	1.0	1.2	1.0*	2.1	2.0
0.7	.85	1.00	0.9	0.8	1.0*	1.4*	2.0	2.2
0.5	1.0	1.00	0.9	0.8	1.2*	1.6	2.2	2.2
0.8 *	0.75	1.00	0.6	1.0*	1.9*	1.7	2.0	2.0
1.35*	1.1	1.5	0.9	2.1*	1.8*	2.0	1.8	1.7
0.8	2.0	2.4	1.5	1.7*	1.6*	2.0	1.5	1.3
1.4	2.0	2.4	1.7	1.4	1.8*	2.1	1.4	1.2
1.65	1.95	2.4	1.4	1.6*	1.9*	2.0	1.2	1.0
1.7	2.00	2.5	1.2	1.4	2.0*	1.9*	1.2	1.1
1.5	2.2	2.6	1.6	1.8	1.8*	2.0	1.3	1.2
1.4	2.2	2.4	1.8	2.0*	1.6*	2.0	1.4	1.3
1.45	2.0	1.8	1.5	2.2*	1.6*	2.4	1.6	1.5
1.5	1.1	0.6	0.4	2.4*	1.8*	2.3	1.9	1.6
1.4	0.7	0.5	0.3	2.0*	2.2*	2.0	2.1	1.7
1.1	0.6	0.5	0.0	1.0	1.8	2.1	2.2	1.9
1.2	0.7	0.6	0.4	0.5	1.4	2.0	2.2	2.0
1.3	0.9	0.7	0.6	0.6	1.4	2.0	2.3	2.3
1.2	1.1	0.8	0.6	0.8	1.1	2.2	2.4	2.4
1.2	1.1	1.2	1.1	1.7	1.4	2.0	2.4	2.2
1.4	1.3	1.5	1.4	1.8	1.4	1.6	2.3	2.4

TABLE 6.3

MONTHLY MEDIAN

	1949		1955	
	June		June	Aug
0-1	0.15	00-01	2.6	2.5
1-2	0.00	01-02	2.5	2.3
2-3	0.00	02-03	2.4	2.4
3-4	0.15	03-04	2.4	2.2
4-5	0.20	04-05	2.5	2.2
5-6	0.00	05-06	2.4	2.3
6-7	-0.15	06-07	2.4	2.4
7-8	-0.25	07-08	1.9	2.4
8-9	-0.50	08-09	1.9	2.3
9-10	-0.50	09-10	1.8	2.1
10-11	-1.00	10-11	1.6	1.9
11-12	-1.00	11-12	1.3	2.4
12-13	-0.50	12-13	1.2	1.8
13-14	-1.00	13-14	1.2	1.8
14-15	-0.55	14-15	1.5	1.9
15-16	-1.00	15-16	1.6	2.2
16-17	-0.25	16-17	2.0	2.4
17-18	-0.10	17-18	2.1	2.4
18-19	0.10	18-19	2.5	2.8
19-20	0.30	19-20	2.6	2.6
20-21	0.40	20-21	2.6	2.7
21-22	0.50	21-22	2.6	2.7
22-23	0.60	22-23	2.8	2.7
23-24	0.65	23-24	2.6	2.4

NORTHWAY - COLLEGE 4 mc

4095 kc Short Path E-W

Sept	Oct
1.4	1.2*
1.2	1.2*
1.5	1.3*
1.2	1.4*
1.2	1.0*
1.4	1.1*
1.9*	1.9*
2.1	2.6*
2.1	2.4*
1.7	2.2*
1.7*	2.2*
1.8*	2.2*
1.8	2.0*
2.0	2.0*
2.2	2.2*
2.3	2.2*
2.3	2.4*
2.4	2.4*
1.9	2.4*
2.2	2.6*
2.0	2.0*
1.8	1.8*
1.4	1.4*
1.4	1.4*

TABLE 6.4

MONTHLY MEDIAN

	1949						1950	
	Jul	Aug	Sep	Oct	Nov	Dec	Jan	Feb
00-01	0.75	0.30	0.05	-0.40	-0.25	0.20	1.95	2.30*
01-02	0.60	0.40	-0.20	-1.00	-0.35	0.20	2.00	2.05*
02-03	0.50	0.45	0.00	-1.00	-1.00	0.20	2.10	2.30*
03-04	0.40	0.15	0.05	-1.00	-1.00	0.30	2.15	2.35*
04-05	0.40	0.00	-0.10	-1.00	-1.00	0.20	2.30	2.50*
05-06	0.40	0.20	-0.10	-0.40	-1.00	0.30	2.10	2.20*
06-07	0.40	0.30	0.00	-1.00	-1.00	0.05	1.90	2.20*
07-08	0.10	-0.05	0.00	-1.00	-1.00	0.00	1.65	2.70*
08-09	0.05	-0.05	-0.30	-1.00	-0.50	0.40	2.10	2.50*
09-10	-0.05	-0.30	-1.00	-1.00	-1.00	0.20	2.20	2.20*
10-11	-0.10	-0.45	-1.00	-1.00	-1.00	0.10	2.00	1.70*
11-12	-0.20	-1.00	-1.00	-1.00	-1.00	0.05	1.90	1.85*
12-13	-0.10	-1.00	-1.00	-1.00	-1.00	0.10	1.60	1.80*
13-14	-0.20	-1.00	-1.00	-1.00	-0.45	0.10	1.90	2.05*
14-15	-0.25	-1.00	-1.00	-1.00	-0.10	0.30	2.20	2.20*
15-16	-0.20	-1.00	-0.20	-0.20	-0.25	0.40	2.40	2.45*
16-17	-0.20	-0.70	-0.20	-0.40	-0.40	0.40	2.60	2.60*
17-18	0.00	0.00	0.00	-0.15	-0.20	0.50	2.55	2.70
18-19	0.35	0.10	0.25	-0.20	-0.15	0.20	1.90	2.60
19-20	0.35	0.15	0.55	-0.05	0.30	0.05	1.60	2.50
20-21	0.50	0.40	0.45	0.20	0.10	-0.10	1.60	2.70*
21-22	0.50	0.50	0.30	0.00	-0.20	-0.10	1.65	2.20*
22-23	0.70	0.55	0.10	-0.10	-0.25	0.10	1.80	1.90*
23-24	0.70	0.35	0.05	-0.15	-0.15	0.15	1.90	2.00*

ANCHORAGE - COLLEGE

4240 kc S-N Short Path 4 mc

Mar	Apr	May	Jun	Jul	Aug	Sep	Oct	Nov	Dec
1.90	0.80*	1.00	1.65	1.85	1.85	0.95	0.50	0.50	1.10
2.30	0.80*	0.95	1.50	1.45	1.70	1.10	0.80	0.50	0.80
2.30	0.65*	0.70	1.45	1.70	1.65	0.90	0.90	0.40	1.05
2.40	0.60*	0.60	1.45	1.80	1.70	0.80	0.85	0.20	0.80
2.30	0.40	0.40	1.30	1.65	1.70	0.80	0.60	0.50	1.00
2.25	0.20	0.80	1.15	1.60	1.50	0.55	0.25	0.45	0.50
2.25	-0.10	-1.00	0.90	1.00	1.45	0.75	-0.20	0.30	0.40
2.20	-0.20	-0.25	0.55	0.80	1.50	1.05	-0.20	0.35	0.60
2.10	-0.40	-0.45	0.25	0.80	0.90	1.20	0.60	1.05	0.70
2.00	-1.00	-1.00	0.20	0.40	0.20	0.70	0.30	-0.30	1.50
2.00	-1.00	-1.00	0.20	0.20	0.40	0.25	0.30	0.25	1.60
1.80	-1.00	-1.00	0.30	0.20	0.50	-0.15	0.40	-0.15	1.20
1.80	-1.00	-1.00	0.10	0.50	0.50	-0.55	0.20	0.05	1.40
1.90	-1.00	-1.00	0.20	0.70	0.45	0.25	0.40	0.20	1.40
2.10	-1.00	-1.00	0.30	0.40	0.80	0.40	0.30	0.35	1.70
2.30	-0.15	-1.00	0.40	0.80	1.00	0.65	0.55	0.40	1.80
2.50	-0.05	-1.00	0.45	0.90	1.40	0.80	0.65	1.20	1.45
2.55	0.25	-0.20	0.70	1.20	1.80	1.05	1.05	0.70	0.90
2.75	0.25	0.65	0.80	1.30	1.85	1.25	1.00	0.50*	0.55
2.60	0.70	0.45	0.90	1.50	1.55	1.50	1.25	0.60	0.45
2.60	0.80	0.80	1.20	1.80	1.80	1.40	1.20	1.00	0.80
2.30	0.75	1.50	1.20	1.90	1.85	1.40	1.10	0.80*	1.10
2.10	0.70	1.30	1.60	1.90	2.10	1.10	0.90	0.80	1.20
2.25	0.60	1.20	1.55	1.70	1.90	0.80	0.90	0.70	1.10

TABLE 6.5

MONTHLY MEDIAN

4 mc

SHE

1954

	Jan	Feb	Mar	Apr	May	Jun	Jul	Aug	Sep
00-01	0.90	0.70	1.05	1.10	1.70	2.20	1.95	1.70	0.95
01-02	0.80	0.60	0.85	1.30	1.80	2.25	1.70	1.70	1.30
02-03	1.00	0.55	0.50	1.35	1.85	2.25	1.70	1.80	1.50
03-04	0.95	0.75	0.45	0.85	1.80	2.20	1.95	1.30	1.25
04-05	0.70	0.60	0.40	0.50	2.00	2.30	1.90	1.10	0.70
05-06	0.60	0.35	-0.10	0.60	1.90	2.30	1.95	1.40	0.25
06-07	0.50	0.10	0.10	0.70	1.80	2.30	1.90	1.50	-0.10
07-08	0.60	0.10	0.20*	1.05	2.00	2.40	1.90	1.50	0.20
08-09	0.60	-0.10	0.25*	0.80	2.30	2.30	2.30	1.70	0.10
09-10	1.50	0.20	0.15*	1.15	2.30	2.20	2.20	2.00	0.20
10-11	1.80	1.00	0.40*	1.60	2.20	2.10	2.00	2.10	0.20
11-12	2.20	0.60	0.15*	1.70	2.10	2.00	2.00	2.00	0.80
12-13	2.05	1.00	1.00*	1.65	2.00	2.00	2.10	2.10	0.80
13-14	2.00	1.30	0.45	1.70	2.10	2.00	2.10	2.10	0.60
14-15	2.25	1.00	0.75	1.45	2.20	2.20	2.10	2.10	0.70
15-16	2.2	1.00	0.90	0.85	2.30	2.50	2.20	1.40	0.70
16-17	0.80	1.30	0.60	0.70	2.15	2.30	1.85	1.20	0.90
17-18	0.30	0.40	0.50	1.10	2.15	2.30	2.00	1.40	0.75
18-19	0.20	-0.25	0.40	1.45	2.20	2.50	2.00	1.70	0.30
19-20	0.20	0.15	0.20	1.35	2.20	2.65	2.35	1.90	0.70
20-21	0.30	0.20	0.25	1.45	1.90	2.70	2.00	1.30	1.00
21-22	0.50	0.45	0.50	1.30	1.70	2.70	1.95	1.50	1.30
22-23	0.60	0.50	0.85	1.00	1.40	2.45	1.70	1.60	1.30
23-24	0.70	0.50	1.00	1.05	1.30	2.25	2.00	1.70	1.00

EP MOUNTAIN - COLLEGE

4240 kc

Short Path S-N

1955

Oct	Nov	Dec	Jan	Feb	Mar	Apr	May	Jun
1.05	1.35	1.35	1.3	1.5	0.9	1.2	1.9	1.9
1.30	1.50	1.45	0.8	1.6	1.0	1.3	1.8	1.9
1.20	1.60	1.50	1.0	1.5	0.9	1.6	1.8	2.0
1.00	1.20	1.25	1.0	1.0	1.0	1.3	1.8	2.0
0.80	1.10	1.15	0.8	0.8	0.9	0.8*	1.8	2.1
0.65	0.90	0.90	0.9	0.9	0.7	1.0*	2.0	2.2
0.30	0.90	1.00	0.8	0.8	0.9*	1.3	2.0	2.0
0.50	0.80	1.00	0.8	0.7	1.4*	1.2	2.0	2.2
1.20	1.40	1.15	0.8*	1.5	1.7*	1.7*	2.0	2.0
1.00	2.05	2.20	1.6	1.9	1.6*	1.8	1.9	1.8
1.20	1.90	2.40	2.0	1.7	1.3*	2.0	1.8	1.5
1.40	2.10	2.40	1.6	1.6	1.7*	2.1	1.6	1.4
1.70	2.10	2.50	1.2	1.8	1.6*	2.2*	1.6	1.3
2.00	2.20	2.60	1.9	2.1	1.8*	2.1	1.7	1.4
1.90	2.30	2.60	2.0	2.2	1.6*	2.2	1.9	1.5
1.65	2.10	1.80	2.1	2.2	1.0	2.1	1.9	1.6
1.40	1.00	0.80	1.2*	2.3	1.5*	2.2	2.1	1.8
2.10	0.60	0.70	0.2*	1.9	1.7	2.2	2.0	1.8
1.00	0.80	0.60	0.4*	0.9	1.4	2.0	2.3	2.2
0.60	0.70	0.70	0.4*	0.5	1.0	1.8	2.1	2.0
0.80	0.60	0.90	0.5*	0.5	1.1	1.1	2.1	2.3
0.90	0.90	1.00	0.7	0.8	1.2	1.6	2.0	1.9
0.80	0.90	1.05	0.9	1.0	1.2	1.6	2.2	1.8
1.00	1.00	1.20	1.0	1.4	1.0	1.2	2.0	2.0

TABLE 6.6

MONTHLY MEDIAN

4240 kc

Anchorage - College

June - 1949

00-01	0.10
01-02	0.05
02-03	-0.10
03-04	0.00
04-05	-0.05
05-06	0.00
06-07	-0.40
07-08	-0.35
08-09	-0.50
09-10	-1.00
10-11	-1.00
11-12	-1.00
12-13	-1.00
13-14	-1.00
14-15	-1.00
15-16	-1.00
16-17	-1.00
17-18	-1.00
18-19	-0.20
19-20	0.15*
20-21	0.00
21-22	0.30
22-23	0.35*
23-24	0.40

Short Path S-N 4 mc

Sheep Mountain - College

1955	Jul	Aug	Sep	Oct
00-01	2.2	2.2	1.30	1.8*
01-02	2.3	2.0	1.50	2.0*
02-03	2.2	2.1	1.55	2.0*
03-04	2.4	1.9	1.80	1.9*
04-05	2.4	1.8	1.40	1.6*
05-06	2.3	2.1	1.20	1.6*
06-07	2.3	2.1	1.55	1.8*
07-08	2.4	2.2	1.85	2.0*
08-09	2.2	2.4	2.0	2.5*
09-10	2.1	2.3	2.00	2.4*
10-11	2.0	2.2	1.95	2.4*
11-12	1.8	2.1	1.90	2.4*
12-13	1.7	1.9	2.1	2.3*
13-14	1.8	2.0	2.15	2.3*
14-15	1.8	2.1	2.30	2.4*
15-16	1.9	2.3	2.40	2.5*
16-17	2.2	2.3	2.30	2.6*
17-18	2.3	2.3	2.30	2.8*
18-19	2.4	2.4	2.20	2.7*
19-20	2.5	2.4	2.25	2.4*
20-21	2.5	2.6	1.65	1.7*
21-22	2.4	2.2	1.60	1.5*
22-23	2.4	2.2	1.30	1.7*
23-24	2.5	2.1	1.50	2.0*

TABLE 6.7

MONTHLY MEDIAN

NORTHWAY -

	1949						1950			
	Jul	Aug	Sep	Oct	Nov	Dec	Jan	Feb	Mar	Apr
00-01	0.20*	0.55	0.20	0.00*	0.65*	0.35	1.10	1.00	1.70	1.30
01-02	0.10*	0.70	0.10*	-0.10*	0.40*	0.40	1.30	1.20	1.20	1.30
02-03	0.25	0.30	0.10*	-0.45*	0.10*	0.30	1.30	1.15	1.20	1.10
03-04	0.10	0.15	0.00*	-0.45	0.30*	0.20	0.90	1.20	1.10	1.00
04-05	0.10*	0.00	-0.10*	-0.45	0.05*	0.10	0.80	1.00	1.10	0.75
05-06	0.10*	0.00	-0.20*	-0.45	0.05*	0.10	0.70	0.80	0.55	0.70
06-07	0.40*	-0.20	-1.00*	-1.00*	-0.25*	0.20*	0.60	0.60	0.40*	0.50
07-08	0.20*	-0.30	-1.00*	-1.00*	-0.35*	0.10	0.35	0.60*	0.40*	0.20
08-09	0.00*	-0.45	-1.00*	-1.00*	-0.30*	0.35	0.05	0.60	0.60	0.10
09-10	-0.30*	-1.00	-1.00	-1.00	-0.60*	0.90	1.85	1.40	0.90	-0.10
10-11	-0.05*	-1.00	-1.00	-0.75	-0.40*	1.05	1.75	2.00	1.90	-0.10
11-12	-1.00#	-1.00	-1.00	-0.35	0.05*	1.20	2.15	2.20	2.20	0.00
12-13	-0.30*	-1.00	-1.00	-0.50	0.20*	1.20	2.20	2.40	2.30	0.10
13-14	-1.00*	-1.00	-1.00	0.15	0.40*	1.25	2.20	2.40	2.40	0.20
14-15	-1.00*	-0.30	-1.00	0.20	0.20*	1.30	2.40	2.30	2.40	0.05
15-16	-1.00#	-0.30	-0.70*	0.20	0.80*	1.30	2.35	2.20	2.40	0.75
16-17	-1.00*	-0.05	-0.40	0.20	0.85*	1.25	2.20	1.90	2.50	1.00
17-18	-0.30*	0.00	-0.40	0.15	0.75*	0.75	1.30	1.95	2.40	1.30
18-19	-1.00*	0.10	-0.05	-0.15	0.00*	0.35	0.85*	1.30	1.80	1.20
19-20	-1.00	0.00	-0.10*	-0.20*	0.25*	0.15*	0.80*	1.10	1.40	1.20
20-21	-1.00	0.15	-0.10*	-0.35*	0.50*	0.10*	0.85*	0.80*	1.00	1.45
21-22	-1.00*	0.30	0.05	0.15*	0.70*	0.30*	1.50#	0.80*	0.90	1.00
22-23	-1.00*	0.55	0.00	-0.45*	0.50*	0.60*	1.80*	0.90	1.00	1.00
23-24	-0.30	0.40	0.20	-0.15*	0.35*	0.20*	1.20*	1.00	1.10	1.20

- COLLEGE

7940 kc E-W Short Path 8mc

May	Jun	Jul	Aug	Sep	Oct	Nov	Dec
1.30	1.10	0.80	1.00*	0.60	0.50#	0.20#	0.30*
1.30	1.20	1.05	1.00*	0.50	-0.10#	-0.20#	0.40#
0.90	1.00	1.10	1.20*	0.55*	-0.25#	-1.00#	0.15#
0.90	1.00	1.10	0.70*	0.60*	-0.30#	-1.00#	-1.00#
0.90	1.20	0.70	0.30*	0.55*	-1.00#	-1.00#	-0.05#
0.90	0.90	0.70	0.40*	0.15*	-1.00#	-1.00#	-1.00#
0.80	0.70	0.50	0.20*	0.20#	-1.00*	-	-
0.30	0.55	0.50	0.20	-0.35*	-1.00#	-	-
0.10	0.40	0.40	-0.30	-1.00*	-1.00#	-1.00#	-1.00#
0.20	0.30	0.30	-0.20	-1.00*	-1.00*	-1.00*	-1.0 #
0.20*	0.30	0.20	-0.10	-1.00*	-1.00*	-1.00*	0.40*
0.20	0.30	0.00	-0.10	-0.50*	-1.00*	-1.00*	0.70*
0.25*	0.30	0.20	-0.20	-0.50*	-0.40	-0.50	0.75
0.20	0.30	0.30	-0.20	-0.50*	-0.50	-0.20	0.95
0.20	0.60	0.20	-0.20	-0.50*	-0.30*	0.25*	0.45*
0.20	0.35	0.25	0.00	-0.25*	0.30*	-0.50*	-0.20#
0.50	0.50	0.25	0.30*	0.20*	0.10#	-	-
0.80	0.70	0.35	0.40*	0.45*	-1.00#	-	-
0.80	0.85	0.50	0.50*	0.20*	-1.00#	-	-
0.60	1.00	0.70	0.50*	0.60*	-	-	-
0.90	1.10	0.70	0.55*	0.60*	-	0.80#	-
1.10	1.00	0.70	0.60*	0.60*	0.30#	0.70#	-
1.20	1.25	0.70	0.75*	0.60	-	-	0.60#
1.40	1.20	0.90	0.70*	0.50	-1.00#	-	0.70#

TABLE 6.8

MONTHLY MEDIAN

1954

	Jan	Feb	Mar	Apr	May	Jun	Jul	Aug
00-01	0.4	0.85	1.00	1.00	1.20	1.00	1.0	1.05
01-02	0.6	0.90	0.80	1.30	1.20	1.20	1.4	1.65
02-03	0.6	0.70	1.00	1.20	1.5	1.25	1.4	1.35
03-04	0.7	0.80	0.5	0.8	1.2	1.35	0.3	0.95
04-05	0.5	0.60	0.30	0.5	0.9	1.2	1.1	0.65
05-06	0.5	0.45	0.30	0.8	0.9	1.15	1.05	0.8
06-07	0.5	0.25	0.0	0.7	0.7	1.00	0.8	0.5
07-08	0.2	-0.1	-0.05	0.45	0.55	0.8	0.7	0.3
08-09	0.2	-0.1 *	0.0 *	0.3	0.6	0.70	0.5	0.3
09-10	0.2	-0.1 *	-0.05*	0.1	0.4	0.7	0.6	0.3
10-11	0.3	-0.1 *	-0.1 *	0.1	0.4	0.7	0.5	0.2
11-12	0.2	-0.2 *	-0.3 *	0.1	0.4	0.9	0.4	0.3
12-13	0.3	-0.3 *	-0.4 *	0.1 *	0.3	0.7	0.55	0.25
13-14	0.3	-0.3 *	-0.3 *	0.0 *	0.4	0.6	0.55	0.2
14-15	0.3	-0.3	-0.4 *	0.0	0.2	0.55	0.45	0.2
15-16	0.3	-0.3 *	-0.35*	0.0 *	0.2	0.50	0.45	0.1
16-17	0.4	0.50	0.4 *	0.9	0.25	0.5	0.45	0.0
17-18	0.05	0.20	0.4	1.8	0.5	0.4	0.40	0.2
18-19	0.00	-0.1	0.0	0.2	0.35	0.5	0.5	0.4
19-20	0.1	0.0	0.0	0.2	0.4	0.5	0.6	0.7
20-21	0.2	0.1	0.3	0.3	0.5	0.6	0.8	0.5
21-22	0.2	0.15	0.3	0.5	0.5	0.7	0.7	0.8
22-23	0.3	0.35	0.7	0.7	0.6	0.7	0.8	0.9
23-24	0.5	0.5	1.00	0.8	0.8	0.8	0.8	0.9

NORTHWAY-COLLEGE

7580 kc Short Path E-W 8 mc

1955

Sep	Oct	Nov	Dec	Jan	Feb	Mar	Apr	May	Jun
1.10	1.00	0.9	0.85	0.5	1.1 *	1.0	1.6 *	0.9 *	0.8*
1.15	1.00	1.1	0.80	0.6	1.0	0.8	1.4 *	1.0 *	0.9*
1.15	1.2	1.0	0.65	0.5	1.5 *	0.6	1.5 *	(1.0) #	1.4*
0.9	0.8	0.7	0.6	0.5	0.7 *	0.8*	0.2 *	1.0 *	1.2*
0.5	0.8	0.7	0.6	0.5	1.0 *	0.8*	0.9 #	0.6 *	0.9
0.2	0.5	0.7	0.6	0.3*	0.7 *	(0.8) #	-	0.8 #	0.8*
0.05	0.25	0.6	0.5	0.6	0.6 *	-	(0.4) #	0.4 #	0.6*
0.0 *	0.2	0.4	0.5	0.2*	(0.2) #	-	-	(0.2) #	0.6
0.0 *	0.3	0.3	0.4	0.3*	(0.3) #	-	(0.2) #	0.2 *	0.4
-0.15*	0.15	0.45	0.4	0.3*	(0.2) #	-	(0.3) #	0.2 *	0.3
-0.15*	0.2	0.3	0.6	0.4*	(0.2) #	-	(0.3) #	0.1 *	0.3
-0.15*	0.5 *	0.3	0.6	0.4	(0.1) #	-	(0.3) #	0.3 *	0.3
-0.25*	0.3 *	0.45	0.8	0.4*	(0.6) #	-	(0.1) #	0.1 *	0.3
-0.30*	0.35*	0.6	0.7	0.6*	(0.3) #	-	(0.1) #	0.1 *	0.3*
-0.20*	0.45*	0.6	0.7	0.6*	(0.6) #	-	-	0.2 *	0.1*
-0.20*	0.55*	0.4	0.6	0.4*	(0.6) #	-	-	0.1 *	0.1*
-0.05*	0.5	0.4	0.4	0.1*	(0.6) #	-	-	(0.2) #	0.2*
-0.10	0.5	0.5	0.4	0.1#	(0.4) #	-	-	(0.3) #	0.6#
0.0	0.5	0.5	0.3	0.1*	(0.2) #	-	-	(0.5) #	(0.6) #
0.50	0.5	0.55	0.45	0.2*	-	-	-	(1.4) #	(0.5) #
0.6	0.5	0.6	0.5	0.3*	(0.2) #	(1.2) #	(0.6) #	(0.6) #	(0.4) #
0.8	0.7	0.6	0.5	0.4*	(0.4) #	1.7*	0.5*	0.9 *	0.5*
1.00	0.8	0.6	0.6	0.5*	(1.0) #	1.4*	0.5*	0.4	0.6
0.3	1.1	0.7	0.6	0.5	1.1 *	0.8*	1.0*	0.4	0.6

TABLE 6.9

MONTHLY MEDIAN

June 1949	7940 kc	1955
00-01	0.00	00-01
01-02	0.10	01-02
02-03	0.30	02-03
03-04	-0.05	03-04
04-05	-0.10	04-05
05-06	-0.20	05-06
06-07	-0.25*	06-07
07-08	-0.50*	07-08
08-09	-1.00*	08-09
09-10	-1.00*	09-10
10-11	-0.35*	10-11
11-12	-0.25*	11-12
12-13	-0.10*	12-13
13-14	-0.10*	13-14
14-15	-0.20*	14-15
15-16	-0.30*	15-16
16-17	-0.45*	16-17
17-18	-0.35	17-18
18-19	-0.40	18-19
19-20	-0.50	19-20
20-21	-0.40	20-21
21-22	-0.25	21-22
22-23	-0.15	22-23
23-24	0.05*	23-24

NORTHWAY - COLLEGE

Short Path E-W 8 mc

7580 kc

Jul	Aug	Sep	Oct
1.2*	1.6*	1.00	(0.6)#
1.6*	1.6*	0.80	(1.0)#
1.7*	1.7*	0.70	(1.1)#
1.2*	1.2*	0.70	(0.9)#
1.2*	1.0*	0.50	(0.5)#
0.8*	(1.3)#	0.15	(0.5)#
0.7*	(1.1)#	0.30*	-
0.6*	(1.1)#	0.15#	-
0.6	(1.0)#	(0.10)#	-
0.6	(0.7)#	-	-
0.5	0.4 *	(0.20)#	(1.4)#
0.6*	0.3 *	(0.10)#	(1.2)#
0.5	0.5 *	(0.10)#	(1.1)#
0.4*	0.2 *	(0.20)#	(2.0)#
0.4*	0.4 #	(0.10)#	2.0 #
0.3*	(1.3)#	-	(1.2)#
0.3*	(0.8)#	-	(0.9)#
(0.2)#	-	-	-
0.6*	-	(0.60)#	-
(0.6)#	-	(0.60)#	-
(0.8)#	(0.5)#	(1.5)#	-
1.2*	(1.3)#	1.0*	-
0.7	0.9	0.55	(0.8)#
0.8	1.3*	0.60*	(1.5)#

TABLE 6.10

MONTHLY MEDIAN

ANCHORAGE - COLLEGE

8 mc

7865 kc Short Path S-N

	1949						1950											
	Jul	Aug	Sep	Oct	Nov	Dec	Jan	Feb	Mar	Apr	May	Jun	Jul	Aug	Sep	Oct	Nov	Dec
00-01	0.25	0.45	0.40	0.35	0.15	-0.1	1.00	1.00*	1.30	1.40	1.40	1.00	1.10	(0.30)#	-	(-0.30)#	-	(0.65)#
01-02	0.2	0.40	0.40	0.15	0.10	-0.1	1.10	1.10*	1.30	1.30	1.30	1.05	1.40	-	(-1.00)#	(0.30)#	-	(0.20)#
02-03	-0.1	0.35	0.30	0.20	-0.05	-0.05	0.90	1.00*	1.20	1.20	0.75	1.00	1.10	(0.30)#	(-1.00)#	(-1.00)#	-	-
03-04	0.1	0.20	0.25	0.10	-0.05	-0.05	1.00	1.10*	1.00	1.00	0.60	1.00	1.00	(-0.40)#	-	-0.30 #	-	(-0.50)#
04-05	-0.05	0.00	0.00	-0.20	0.05	0.15	0.90	1.10*	1.00	0.60	0.70	1.00	0.85	(0.00)#	(-1.00)#	-1.00*	-	-
05-06	0.35	-0.10	-0.15	-0.15	-0.15	-0.05	0.80	1.00*	0.85	0.50*	0.70	1.00	0.80	(-0.70)#	(-1.00)#	-1.00*	(-1.00)#	-
06-07	0.25	-0.20	-0.20	-0.35	-0.20	-0.05	0.70	1.15*	0.70*	-0.20*	0.30	0.80	1.00	(-1.00)#	(-1.00)#	-1.00*	(-1.00)#	-
07-08	-0.15	-0.30	-0.30	-0.25	-0.35	0.0	1.00	1.10*	0.60*	-0.20	0.20	0.70	0.70	(-1.00)#	(-1.00)*	-1.00*	(-1.00)#	-
08-09	-0.15	-0.35	-1.00	-0.25	-0.05	0.2	1.00	1.10*	0.50	0.00	0.10	0.65	0.50	(-1.00)	(-1.00)*	-1.00*	(-1.00)#	-
09-10	-0.20	-0.40	-1.00	-0.20	0.50	0.8	1.60	2.10*	1.10	-0.15	0.00	1.10	0.60	(-1.00)	(-1.00)	-1.00*	(-1.00)#	-1.00#
10-11	-0.20	-1.00	-1.00	0.35	0.80	1.20	1.90	2.40*	1.60	0.00	0.10	0.60	0.50	(-1.00)	(-1.00)	-1.00	(-1.00)#	-1.00*
11-12	-0.10	-1.00	-1.00	0.40	0.85	1.20	2.30	2.40*	2.05	0.00	0.00	0.60	0.50	(-1.00)	(-1.00)*	-1.00	-1.00*	-0.35*
12-13	-0.10	-0.30	-0.20	0.30	0.9	1.15	2.30	2.40*	2.20	0.20	0.10	0.55	0.60	(-1.00)	(-1.00)*	-1.00	-1.00*	0.60*
13-14	-0.05	-0.40	-0.25	0.60	1.05	1.15	2.40	2.40*	2.20	0.40	0.10	0.50	0.60	(-1.00)	(-1.00)*	-0.10	-1.00*	0.45*
14-15	-0.20	-1.00	0.05	0.75	1.15	1.30	2.50	2.40*	2.30	0.50	0.50	0.40	0.80	(-1.00)	(-1.00)*	0.00*	-1.00#	0.50*
15-16	-0.45	-1.00	0.05	1.05	1.00	1.20	2.60	2.60*	2.60	0.60	0.00	0.30	0.80	(-1.00)*	(-1.00)#	(0.20)#		-
16-17	-0.50	-1.00	0.20	1.00	0.85	1.30	2.50	2.60*	2.50	1.20	0.20	0.65	0.60*	(-1.00)#	(-1.00)#	(0.90)#		-
17-18	-0.4	-0.40	0.00	0.95	0.9	0.7	1.70	2.60*	2.45	1.35	0.20	0.85	0.50	(-0.80)#	(-1.00)#	(-0.30)#		-
18-19	-0.30	0.05	0.15	0.5	0.3	0.3	0.90	2.10*	2.10	1.20	0.35	0.80	1.00*	-	(-1.00)#	(-1.00)#		-
19-20	-0.30	0.05	0.10	0.15	0.2	-0.10	1.00	1.20*	2.10	1.20	0.50	0.90	0.90	-	-	-		-
20-21	-0.05	0.05	0.15	0.50	0.25	-0.1	0.80	1.15*	1.20	1.40	0.65	1.00	1.00	-	-	-		-
21-22	-0.1	0.15	0.20	0.05	0.2	0.00	0.70	1.00*	1.15	1.40	0.75	1.10	1.00	-	-	(0.50)#		0.50#
22-23	0.20	0.30	0.00	0.2	0.05	-0.1	1.00	0.85*	1.20	1.20	0.90	1.20	1.10	-	(-1.00)#	(0.60)#		1.00#
23-24	0.25	0.35	0.35	0.3	0.05	-0.1	0.70	0.80*	1.30	1.30	1.00	1.20	1.10	-	(-1.00)#	(-1.00)#		0.35#

TABLE 6.11 MONTHLY MEDIAN SHEEP MOUNTAIN - COLLEGE 7940 kc Short Path S-N
1954 1955

	Jan	Feb	Mar	Apr	May	Jun	Jul	Aug	Sep	Oct	Nov	Dec	Jan	Feb	Mar	Apr	May	Jun
00-01	0.60	0.60	0.60	1.00	1.20	0.55	0.50	0.60	0.50	0.70	0.40	0.50	0.7*	(0.8)#	0.4*	1.2#	0.7#	0.5*
01-02	0.60	0.65	0.60	0.90	1.10	0.55	0.70	0.60	0.80	0.70	0.50	0.50	0.4	(1.1)#	0.4*	1.0*	0.5*	0.6
02-03	0.60	0.50	0.50	0.70	1.00	0.55	0.80	0.60	0.40	0.70	0.50	0.50	0.4	0.4*	0.6*	0.6	0.3*	0.6
03-04	0.60	0.50	0.40	0.50	0.90	0.60	0.50	0.50	0.40	0.40	0.50	0.40	0.4	0.4*	0.6*	0.4*	0.3*	0.6
04-05	0.50	0.40	0.30	0.40	1.10	0.50	0.50	0.40	0.30	0.30	0.30	0.50	0.3	0.4	0.2*	0.2*	0.3*	0.5
05-06	0.50	0.20	0.10	0.50	1.00	0.50	0.40	0.40	0.00	0.10	0.30	0.40	0.3	0.4*	(0.2)#	(0.2)#	0.3*	0.4
06-07	0.40	0.30	0.10	0.60	0.90	0.50	0.40	0.30	-0.15	0.10	0.25	0.50	0.4	0.3*	-0.50#	-0.50#	0.2*	0.4
07-08	0.40	0.25	0.10	0.70	0.70	0.40	0.30	0.20	-0.30	0.10*	0.20	0.60	0.4*	(0.3)#	-0.50#	-0.50#	0.2*	0.4
08-09	0.40	0.30	0.40	0.50	0.50	0.40	0.30	0.20	-0.20*	-0.10*	0.30	0.40	0.4*	(0.3)#	-0.50#	-0.50#	0.2*	0.4
09-10	0.40	0.45	0.05	0.30	0.30	0.45	0.30	0.10	-0.20*	0.00*	0.30	0.50	0.6#	-0.50#	-0.50#	-0.50#	0.0*	0.3
10-11	0.6	0.20	0.10*	0.20	0.30	0.40	0.20	0.10	-0.30*	0.00	0.20	0.60	0.4*	-0.50#	-0.50#	-0.50#	0.1	0.2
11-12	0.4	0.00	-0.10*	-0.10	0.20	0.40	0.20	0.10	-0.20*	-0.20	0.20	0.50	0.6*	(0.2)#	-0.50#	-0.50#	0.0*	0.2
12-13	0.4	0.10*	0.00*	0.00*	0.10	0.40	0.20	0.00	-0.40*	-0.20*	0.20	0.70	0.5*	(0.0)#	-0.50#	-0.50#	0.0	0.2
13-14	0.40	0.00*	-0.20*	0.05*	0.10	0.30	0.20	0.00	-0.30	0.10*	0.50	1.30	0.7*	(0.3)#	-0.50#	(0.1)#	0.1*	0.3
14-15	0.50	-0.10*	-0.20*	0.10*	0.00	0.20	0.00	0.00	-0.25*	0.20*	0.50	0.10	0.8*	(0.1)#	-0.50#	(0.0)#	0.0*	0.4
15-16	0.30	0.00	0.00*	0.00*	0.10	0.20	0.10	0.20	-0.35*	0.20*	0.35	0.20	0.5*	(0.6)#	-0.50#	-0.50#	0.1*	0.1*
16-17	0.40	0.30	-0.10*	0.10	0.00	0.10	0.00	-0.10	-0.10*	0.10	0.20	0.30	0.3*	0.4*	-0.50#	(0.1)#	0.0*	0.1*
17-18	0.20	0.10	-0.20	-0.10*	0.00	0.10	0.00	-0.10	-0.30*	0.15	0.10	0.30	-0.50#	(0.1)#	-0.50#	(0.2)#	0.1*	0.1*
18-19	0.2	0.10	-0.10	0.00	0.20	0.15	0.20	0.00	-0.10	0.10	0.20	0.20	0.1#	(0.3)#	-0.3#	-0.50#	0.1*	0.2*
19-20	0.2	0.10	0.20	0.00	0.30	0.20	0.20	0.20	0.10	0.00	0.10	0.20	0.2#	(0.2)#	(0.4)#	0.4*	0.2	0.3
20-21	0.3	0.20	0.30	0.40	0.40	0.40	0.40	0.30	0.20	0.15	0.20	0.30	0.4#	0.2#	0.5*	0.4*	0.4	0.3
21-22	0.40	0.30	0.40	0.90	0.75	0.40	0.40	0.40	0.35	0.30	0.30	0.30	0.4#	(0.3)#	1.2*	0.5	0.4	0.4
22-23	0.40	0.30	0.80	1.10	1.00	0.40	0.40	0.40	0.50	0.40	0.40	0.40	0.4*	(0.5)#	1.1*	0.4#	0.4	0.5
23-24	0.50	0.40	0.80	1.20	1.20	0.45	0.50	0.40	0.60	0.50	0.30	0.50	0.3*	0.6#	0.7*	0.8*	0.6	0.6

TABLE 6.12

MONTHLY MEDIAN

Anchorage - College 7865 kc

June - 1949

00-01	.15*
01-02	.05*
02-03	0.1
03-04	-0.10
04-05	-0.1
05-06	-0.2
06-07	-0.4
07-08	-0.25
08-09	-0.25
09-10	-0.25
10-11	-0.40
11-12	-0.40
12-13	-0.2
13-14	-0.25
14-15	-0.50
15-16	-0.55
16-17	-1.0
17-18	-1.0
18-19	-0.35
19-20	-0.15
20-21	-0.1
21-22	-0.1*
22-23	0.5*
23-24	0.2*

Short Path S-N

8 mc

Sheep Mountain - College 7940 kc

1955	Jul	Aug	Sep	Oct
00-01	0.7	1.2*	1.0*	0.6*
01-02	0.8	1.3	0.8	0.8*
02-03	0.7	1.0	0.6	0.6*
03-04	0.9*	0.8	0.5	0.5*
04-05	0.6	0.7	0.3	0.2*
05-06	0.5*	1.0*	0.1*	0.3*
06-07	0.5*	0.5*	0.1*	0.4#
07-08	0.6	(0.6)#	(0.1)#	(0.4)#
08-09	0.5*	0.4#	(0.2)#	(0.6)#
09-10	0.4	0.4*	(0.4)#	-0.50#
10-11	0.4	0.3*	(0.2)#	0.6#
11-12	0.4*	0.4*	(0.0)#	1.4#
12-13	0.3*	0.3*	(-0.2)#	1.5*
13-14	0.3*	0.3*	(0.1)#	1.6*
14-15	0.2*	0.3*	0.1*	1.2*
15-16	0.4*	0.2*	0.2#	0.8*
16-17	(0.5)#	(0.6)#	0.4#	0.5*
17-18	(0.4)#	(0.8)#	0.2*	0.8*
18-19	0.4*	0.6*	0.4*	0.6*
19-20	0.4*	0.6*	0.4*	0.5*
20-21	0.4	0.9	0.4*	0.4*
21-22	0.6	1.0	0.6	0.4*
22-23	0.7	1.0	0.6	0.5*
23-24	0.8	0.8*	0.6	0.6*

TABLE 6.13

MONTHLY MEDIAN

12305 kc

NORTHWAY -

	1949					1950				
	Jul	Aug	Sep	Oct	Nov	Dec	Jan	Feb	Mar	
00-01	0.0	0.1	0.3	0.25*	0.25	0.40*	0.5*	0.35	0.5	
01-02	0.0	0.2	0.15	0.05	0.2	0.35*	0.5*	0.1	0.3	
02-03	-0.5	0.1	0.1	0.1	0.15	0.20*	0.35*	0.2*	0.3	
03-04	-0.1	0.1	0.0	0.05	0.05*	0.35*	0.4	0.3*	0.1	
04-05	-0.1	0.0	0.0	-0.2	0.1	0.45*	0.3*	0.3*	0.2	
05-06	-0.2	0.1	0.0	-0.05	0.15	0.40*	0.3*	0.2*	0.15*	
06-07	-0.15	0.0	0.05	-0.05	0.25	0.40*	0.4*	0.2	0.1*	
07-08	-0.2	-1.0*	0.1	-0.1*	0.1	0.40	0.2*	0.3	0.2*	
08-09	-0.25*	-1.0*	0.1	-0.1*	0.5	0.40	0.2	0.2*	0.1*	
09-10	-0.25*	-1.0*	0.1*	-0.2*	0.25	0.55	0.45	0.2	0.2*	
10-11	-0.3*	-1.0*	0.2*	0.5*	0.15	0.50	0.2	0.4	0.4*	
11-12	-0.1*	(-1.0)#	0.3*	-0.15*	0.15	0.70	0.45	0.5	0.5*	
12-13	-0.25*	-1.0*	0.25*	0.0*	0.2	1.00	0.7	0.5	0.4*	
13-14	-0.15*	-1.0*	-0.15#	0.55*	0.7	0.90	1.0	0.6	0.45	
14-15	-0.25*	-1.0*	-0.05*	0.1	0.65	0.65	0.8	0.4	0.4	
15-16	-0.25*	-0.35	0.0	0.15	0.35	0.45	0.6	0.5	0.4	
16-17	-0.15*	-0.15	-0.05	0.15	0.25	0.35	0.6	0.6	0.4	
17-18	-0.20*	-0.1	-0.05	0.15	0.2	0.10	0.4	0.45	0.5	
18-19	-0.15*	0.1	0.1	0.05	0.15	0.00	0.3	0.35	0.6	
19-20	0.0*	0.1	0.2	0.1	0.10	-0.15	0.2*	0.2	0.5	
20-21	0.0*	0.3	0.55	0.4*	0.20	-0.05	0.4*	0.3	0.7	
21-22	0.1*	0.2	0.45	0.35*	0.40	0.40	0.5*	0.5	0.6	
22-23	0.1*	0.15	0.3	0.4*	0.40	0.60*	0.6*	0.5	0.6	
23-24	0.0*	0.2	0.25	0.15*	0.30	0.40	0.5*	0.3	0.5	

COLLEGE

E-W SHORT PATH 12 mc

Apr	May	Jun	Jul	Aug	Sep	Oct	Nov	Dec
0.4	0.3	0.4	0.3	0.2	0.0	0.2*		0.0*
0.2	0.2	0.3	0.3	0.2	-0.05	0.2*		0.0*
0.1	0.1	0.4	0.2	0.1	-0.1	0.15*		0.0*
0.0	0.15*	0.3*	0.2	-0.2	-0.1	0.1*		0.0*
-0.1	0.0*	0.2	0.1	-0.1	0.0	0.2*		0.0*
0.05	0.0	0.15	0.1	-0.3	-0.2*	0.2*		0.0*
0.1	-0.2	0.2	0.0	-0.4	-1.00*	-0.3#		0.1*
0.0	-0.4	0.0	0.0	-0.5	-1.00*	(-0.2)#		0.0*
-1.00	-0.4	0.0	0.0	-1.00	-1.00*	(0.0)#		0.0*
-1.00*	-0.4	-0.1	0.0	-0.4	-1.00*	(-1.00)#		-0.05*
-1.00*	-0.3	0.0	-0.1	-1.00	-1.00*	-1.00*		0.1*
-1.00#	-0.3	0.0	0.0	-0.3	-1.00*	-1.00*		0.0*
-1.00#	-0.3*	0.1	0.1	-0.1	-1.00*	-1.00*		0.1*
-1.00*	-0.2*	0.0	0.1*	-0.4	-1.00*	-0.3*		0.0*
-0.2	-1.00	0.0	0.0	-1.00	-1.00*	0.0*		0.1*
0.0	-0.4	-0.1	-0.1	-1.00	-1.00*	0.1		0.0*
0.1	-0.3	-0.05	0.0	-0.5	-1.00*	0.2		0.0*
0.2	-0.3	0.1	0.0	-0.3	-1.00	0.2		0.0*
0.4	0.1	0.3	0.1	-0.3	-0.1	0.2		0.0*
0.45	0.1	0.35	0.2	0.0	0.0	0.2		0.0*
0.6	0.3	0.35	0.3	0.2	0.2	0.5*		0.0*
0.4	0.2	0.3	0.2	0.2	0.2	(0.5)#		0.1*
0.4	0.2	0.4	0.2	0.2	0.2	0.4*		0.2*
0.3	0.3	0.3	0.2	0.4	0.1	0.4*		0.2*

TABLE 6.14

MONTHLY MEDIAN

12 mc

1954

	Jan	Feb	Mar	Apr	May	Jun	Jul	Aug	Sep	Oct
00-01	-0.1	0.0	-1.00	0.0	0.2	0.2*	0.4	0.3	0.1	0.25
01-02	-0.2	0.0	-0.5	0.0	0.15	0.2*	0.5	0.3	0.2	0.2
02-03	-0.2	-0.1	-0.45	0.0	0.2	0.3*	0.6	0.4	0.2	0.2
03-04	-0.1	0.0	-0.45	0.0	0.2	0.3*	0.5	0.3	0.2	0.2
04-05	-0.1	0.0	-0.45	0.0*	0.15	0.2*	0.3	0.2	0.1	0.2
05-06	0.0	-0.1	-0.5*	0.0	0.1	0.2*	0.3	0.1	0.0	0.1
06-07	-0.2	-0.15	-0.5*	0.0	0.2	0.2*	0.2	0.1	-0.2	0.1
07-08	-0.2	-0.3	-0.5*	-0.1*	0.1	0.2*	0.2	0.0	0.3	0.0
08-09	-0.3	-0.5*	-0.5#	-0.05*	0.1	0.2*	0.1	0.0	-0.3	-0.1
09-10	-0.3	-0.3*	-0.5*	-0.2*	0.1	0.2*	0.0	-0.05	-0.3*	-0.15
10-11	-0.1	-0.3*	-0.4#	-0.2*	0.1	0.2*	0.0	-0.2	-0.3	-0.25
11-12	-0.3	-0.35*	-0.4#	-0.25*	0.1	0.2*	0.0	-0.2	-0.3	-0.2
12-13	-0.2	-0.3*	-0.4*	-0.2*	0.0	0.2*	0.0	-0.1	-0.4	-0.1
13-14	0.05	-0.2*	-0.4*	0.0*	0.0	0.2*	0.1	-0.1	-0.3	0.0
14-15	0.0	-0.15*	-0.3*	0.0*	0.1	0.2*	0.2	0.0	-0.2	-0.05
15-16	-0.2	-0.3*	-0.4*	0.0	0.2	0.4*	0.3	0.0	-0.3	-0.1
16-17	-0.4	-0.3*	-0.4#	-0.2	0.2	0.4*	0.2	-0.2	-0.2*	-0.2
17-18	-0.4	-0.2	-0.5*	-0.2*	-0.1	0.3*	0.0	-0.35	-0.3	0.0
18-19	-0.4	-0.3	-0.5*	-0.15*	-0.1	0.2*	0.05	-0.1	-0.2	0.0
19-20	-0.4	-0.2	-0.3*	-0.1	0.0	0.15*	0.0	0.0	0.1	0.1
20-21	-0.3	-0.2	-0.3	0.0	0.1	0.15*	0.1	0.0	0.1	0.1
21-22	-0.3	-0.1	-0.3	0.1	0.2	0.2*	0.2	0.0	0.1	0.2
22-23	-0.2	-0.1	-0.3	0.1	0.2	0.3*	0.3	0.1	0.0	0.2
23-24	-0.2	-0.05	-0.5	0.1	0.3	0.35*	0.5	0.2	0.1	0.2

NORTHWAY - COLLEGE

12305 kc Short Path E-W

1955

Nov	Dec	Jan	Feb	Mar	Apr	May	June
0.3	0.3	0.2*	0.6*	-	-	-	(0.6)#
0.3	0.2	0.2*	(0.3)#	(0.40)#	(0.5)#	-	(0.4)#
0.35	0.3	0.2*	(0.6)#	(0.40)#	(0.3)#	-	0.4*
0.3	0.3	0.2*	(0.6)#	(0.50)#	-	-	0.3*
0.4	0.3	0.2*	(0.4)#	(0.40)#	-	-	0.3*
0.45	0.3	0.2*	(0.4)#	-	-	-	0.2*
0.35	0.2	0.2*	(0.2)#	-	-	-	0.2
0.1	0.1	0.2*	-	-	-	-	0.2
0.1	0.1	0.1*	-	-	-	-	0.2
0.1	0.2	0.1*	-	-	-	-	0.1
0.2	0.2	0.1*	-	-	-	-	0.1
0.2	0.3	0.1#	-	-	-	-	0.1*
0.2	0.3	0.2#	-	-	-	-	0.1*
0.3	0.4	0.3#	-	-	-	-	0.1#
0.2	0.3	0.3#	-	-	-	-	(0.1)#
0.1	0.1	0.2#	-	-	-	-	0.0#
0.1	0.0	0.1#	-	-	-	-	(-01)#
0.1	0.1	0.2#	-	-	-	-	0.2#
0.1	0.0	0.1*	(0.3)#	-	-	-	(0.2)#
0.1	0.1	0.1*	(0.3)#	-	-	(0.2)#	0.1#
0.1	0.1	0.1*	(0.3)#	(0.60)#	-	(0.6)#	(0.4)#
0.2	0.2	0.2*	(0.4)#	(1.20)#	-	-	(0.2)#
0.2	0.3	0.2*	(0.4)#	(0.50)#	-	-	(0.2)#
0.3	0.2	0.2*	(0.6)#	(0.60)#	-	-	(0.6)#

TABLE 6.15 MONTHLY MEDIAN

	June 1949	12305 kc
00-01	0.40#	
01-02	0.25#	
02-03	0.20#	
03-04	0.25#	
04-05	0.20#	
05-06	-	
06-07	-	
07-08	-	
08-09	-	
09-10	-	
10-11	-	
11-12	0.30#	
12-13	-	
13-14	-	
14-15	-	
15-16	-	
16-17	-	
17-18	-	
18-19	0.05#	
19-20	0.10#	
20-21	0.20#	
21-22	0.30#	
22-23	0.35#	
23-24	0.35#	

NORTHWAY - COLLEGE

Short Path E-W 12 mc

	1955	12305 kc		
	Jul	Aug	Sep	Oct
00-01	(1.3)#	(1.9)#	0.9	0.1*
01-02	(1.2)#	0.7	0.5	0.1*
02-03	0.4*	0.8*	0.7*	0.1*
03-04	0.4*	1.2*	0.6*	0.25*
04-05	(0.5)#	1.2*	0.4#	0.2*
05-06	(0.4)#	1.1*	0.5#	0.2*
06-07	(0.4)#	1.2*	-	0.0*
07-08	(0.3)#	1.2#	-	0.1*
08-09	(0.3)#	(1.9)#	-	0.1*
09-10	0.3#	(1.1)#	-	0.1*
10-11	(0.3)#	(1.0)#	-	0.1*
11-12	(0.2)#	-	-	0.0*
12-13	(0.2)#	-	-	0.0*
13-14	(0.3)#	-	-	0.0*
14-15	-	-	-	0.15*
15-16	-	-	-	0.2*
16-17	(0.3)#	-	-	0.15*
17-18	-	-	-	0.0*
18-19	-	-	-	0.0*
19-20	-	(1.2)#	(0.3)#	0.1*
20-21	-	(1.2)#	(0.7)#	0.1*
21-22	-	(1.2)#	-	0.3*
22-23	-	-	(1.4)#	0.1*
23-24	(0.8)#	-	(1.0)#	0.3*

TABLE 6.16

MONTHLY MEDIAN

ANCHORAGE - COLLEGE

12070 kc

S-N Short Path 12 mc

	1949						1950											
	Jul	Aug	Sep	Oct	Nov	Dec	Jan	Feb	Mar	Apr	May	Jun	Jul	Aug	Sep	Oct	Nov	Dec
00-01	0.10	-0.10*	0.10#	-	0.65*	0.70	-	-0.20*	0.05*	0.50	0.60*	0.60	(1.05)#	-	(0.60)#	0.60#		0.30*
01-02	-0.10	-0.65*	-0.10*	0.30#	0.10*	0.70	-	-1.00*	0.10*	0.30*	0.55*	0.35	(1.20)#	0.50#	0.25*	0.30#		0.20
02-03	-0.10	-0.15	(-0.20)#	0.20#	0.10#	0.10	-	-1.00*	0.10*	0.50*	0.60*	0.30	(0.80)#	-	0.15*	0.25#		0.25
03-04	-0.05	-0.25	-0.40*	0.00*	0.00#	0.20	-	-0.25*	-0.20*	0.40*	0.35*	0.30	(0.90)#	-	0.00*	(0.35)#		0.20
04-05	-0.15	-1.00	-0.25*	-0.10*	-0.40#	0.60	-	-0.20*	(0.05)#	0.40*	(0.10)#	0.30	(0.80)#	-	0.20*	(0.40)#		0.20
05-06	-	-1.00#	(-1.00)#	-0.20*	-0.30#	-0.40	-	-0.25*	(-0.65)#	0.50*	0.35*	0.30	0.65#	-	0.05#	(0.20)#		0.20
06-07	-	-1.00#	(-0.25)#	-0.40*	-0.15#	0.00	-	-1.00*	(-1.00)#	0.10#	0.10#	0.30	0.30*	-	(-0.20)#	-		0.20
07-08	-	-1.00#	(-1.00)#	-0.30*	(-0.30)#	0.05	(-0.40)#	-1.00*	(-1.60)#	0.00*	-0.20*	0.20	0.10	-	(-1.00)#	-		0.10
08-09	-0.40	-1.00	-0.30#	-0.45#	(-0.75)#	0.25#	-0.10*	-0.40*	(-0.30)#	-0.80*	-0.10*	0.20	0.00	-	(-0.40)#	-		0.10*
09-10	-0.45	-1.00	-0.70*	-0.45*	-0.25#	0.25*	0.00*	-1.00*	-1.00*	-1.00*	-0.40*	0.20	0.00	-	(-1.00)#	-		0.20*
10-11	-0.40	-1.00*	-1.00*	-0.40*	-0.10*	0.30*	0.30	-0.40	-1.00*	-1.00*	-0.25*	0.10*	0.00	-	(-1.00)#	(0.30)#		0.30*
11-12	-0.25*	-1.00*	-0.30*	-0.40*	0.10*	1.05	0.30	-0.35	-0.35	-1.00	-0.20*	0.10*	0.00	-	(-1.00)#	(0.20)#		0.20*
12-13	-0.20*	-1.00*	-0.15*	0.20*	1.00	1.45	0.70	0.10	-0.30	-1.00*	(-1.00)#	0.35*	0.25#	-	(-1.00)#	(0.30)#		0.25
13-14	-0.40*	-1.00*	-0.10*	0.55*	1.15	1.40	1.10	0.45	0.10*	(-1.00)#	(-1.00)#	0.50#	(0.00)#	-	(-1.00)#	-		0.40
14-15	-0.30*	-1.00#	-0.05*	1.00*	1.25	1.45	0.80	0.35	0.10*	(0.05)#	(-0.40)#	0.40#	(0.20)#	-	-1.00#	(0.30)#		0.35
15-16	-0.10#	-1.00#	0.05#	0.95*	0.90	0.95	0.60	0.10	0.20*	0.00#	-1.00*	0.20*	0.10*	-	(-1.00)#	(0.35)#		0.30
16-17	0.00#	(-1.00)#	-0.10#	0.35*	0.60	0.60	0.60	0.15	0.20	0.20*	-1.20*	0.30*	0.10*	-	-1.00#	0.35*		0.40*
17-18	-0.10*	-1.00*	-0.05*	0.40*	0.25	0.40*	0.40	0.15	0.20	0.30	-0.25*	0.50*	0.05*	-	-0.05*	0.40*		0.15*
18-19	-0.05*	(0.00)#	(0.10)#	(0.15)#	(-0.20)#	-0.05#	0.20	0.00*	0.25	0.45*	-0.25#	0.50*	(0.20)#	-	0.20*	(0.45)#		0.20*
19-20	0.10	0.00*	(0.10)#	(0.20)#	-	0.60#	(0.20)#	-0.20	0.15	0.50	0.40*	0.40	0.70#	-	0.40*	(0.50)#		0.20*
20-21	0.25*	0.00*	(0.25)#	(0.10)#	-	0.30#	-	-0.30	0.10	0.50	0.40*	0.40	(0.60)#	0.20#	0.30#	(0.50)#		0.20*
21-22	0.30*	0.05*	-	(0.35)#	-	-0.40	-	0.00*	0.25*	0.40	0.40*	0.40	(0.70)#	0.10#	0.40*	(0.45)#		0.40*
22-23	0.20	0.00*	-	-	(0.40)#	0.45	-	0.00*	0.35*	0.40	0.70*	0.50	0.60#	0.10#	0.25#	(0.60)#		0.35*
23-24	0.25	0.05*	(0.25)#	-	(0.50)#	0.25	-	-0.10*	0.10*	0.40	0.60*	0.40	1.00#	0.20#	(0.20)#	(0.40)#		0.30*

TABLE 6.17 MONTHLY MEDIAN SHEEP MOUNTAIN - COLLEGE 12072.5 kc Short Path S-N 12 mc

	1954												1955					
	Jan	Feb	Mar	Apr	May	Jun	Jul	Aug	Sep	Oct	Nov	Dec	Jan	Feb	Mar	Apr	May	Jun
00-01	0.10	-0.30	-0.20	-0.25	0.00	0.10	-0.10	0.00	-0.20	0.20	0.10	0.10	-	(0.7)#	-	-	-	-
01-02	0.10	-0.20	-0.20	-0.30	-0.10	0.10	0.05	-0.10	-0.20	0.00	0.10	0.10	-	(0.3)#	(0.1)#	(0.2)#	-	(0.5)#
02-03	0.10	-0.25*	-0.20	-0.20	-0.15	-0.10	0.00	-0.10	-0.30	0.00	0.20	0.10	-	-	(0.1)#	-	-	(0.1)#
03-04	0.10	-0.40	-0.15	-0.20	-0.20	-0.15	-0.30	-0.30	-0.30	0.00	0.20	0.10	0.0#	-	(0.3)#	-	-	0.2*
04-05	0.10	-0.20	-0.10	-0.10	-0.20	-0.20	-0.20	-0.45	-0.20*	0.10	0.30	0.20	-	-	(0.0)#	-	-	-0.1
05-06	0.10	-0.10	-0.20	-0.20	-0.15	-0.15	-0.30	-0.30	-0.30*	0.10	0.40	0.20	-	-	-	-	-	0.0*
06-07	0.10	-0.30*	-0.10	-0.20	-0.10	-0.10	-0.30	-0.30	-0.40*	-0.10	0.35	0.20	-	-	-	-	-	(0.1)#
07-08	0.10	-0.10*	-0.20*	-0.25	-0.10	-0.20	-0.30	-0.30	-0.40#	-0.05	0.00	0.00	-	-	-	-	-	-0.1
08-09	0.00	-0.30*	-0.30*	-0.30	0.10	0.00	-0.40	-0.30	(-0.40)#	-0.10	0.00	0.00	-	-	-	-	-	-0.1*
09-10	0.00	-0.40*	-0.40*	-0.40*	-0.10	0.00	-0.40	-0.30	(-0.40)#	-0.20	0.00	0.00	-	-	-	-	-	-0.2*
10-11	0.00	-0.40*	-0.35#	-0.30*	-0.15	0.00	-0.30	-0.30	(-0.35)#	-0.30*	0.00	0.00	-	-	-	-	-	-0.2*
11-12	0.00	-0.30*	-0.40#	-0.35*	-0.20	0.30	-0.30	-0.30	(-0.40)#	-0.40*	0.00	0.10	-	-	-	-	-	(-0.1)#
12-13	0.00	-0.40*	-0.30*	-0.20*	0.10	0.40	-0.25	-0.20	(-0.40)#	-0.30	0.00	0.10	-	-	-	-	-	-
13-14	0.00	-0.30*	-0.15*	0.30*	0.10	0.50	-0.30	-0.10	-0.20*	-0.20	0.10	0.10	0.1#	-	-	-	-	-
14-15	0.00	-0.30*	-0.20*	0.00*	0.10	0.50	-0.10	-0.20	-0.30*	0.00	0.10	0.00	0.1#	-	-	-	-	-
15-16	0.00	-0.25*	-0.30*	-0.05*	0.20	0.60	-0.20	-0.25	-0.20*	-0.25	0.10	0.10	-	-	-	-	-	-
16-17	0.00	-0.35#	(-0.30)#	-0.10*	0.30*	0.80	-0.10	0.00*	-0.35#	-0.30	-0.10	-0.20	-	-	-	-	-	-
17-18	0.00*	(-0.30)#	(-0.50)#	-0.15*	-0.00*	0.80	-0.30	-0.05*	-0.50*	-0.25	-0.10	-0.20	-	-	-	-	-	-
18-19	0.00*	-0.40*	(0.45)*	-0.30*	-0.20*	0.20	-0.30	-0.30*	-0.40*	-0.20	-0.05	-0.20	-	(0.2)#	-	-	-	-
19-20	0.00*	-0.40*	-0.30	-0.40	-0.10*	-0.20	-0.10	-0.10	-0.30	0.00	0.00	-0.20	-	-	-	-	(0.2)#	(-0.1)#
20-21	0.00	-0.20*	-0.10	-0.15	-0.20	-0.10	-0.20	-0.15	-0.10	-0.10	0.00	-0.10	-	-	(0.4)#	0.2*	(0.2)#	-
21-22	0.10*	-0.30	0.15	0.10	-0.10	-0.20	-0.20	-0.20	-0.10	0.00	0.00	-0.10	-	(0.1)#	(0.4)#	-	-	-
22-23	0.10	-0.10	0.20	-0.10	0.05	-0.05	-0.20	0.00	-0.10	0.10	0.10	0.00	-	(0.4)#	(0.6)#	-	-	-
23-24	0.10	-0.15	0.00	-0.20	-0.10	-0.10	-0.20	-0.20	-0.20	0.20	0.20	0.20	-	-	(0.2)#	(0.1)#	-	-

TABLE 6.18 ANCHORAGE - COLLEGE 12070kc

MONTHLY MEDIAN

Short Path S-N

12 mc

SHEEP MOUNTAIN - COLLEGE

12072.5 kc

1955

June 1949		1955			
		Jul	Aug	Sep	Oct
00-01	0.10#	00-01 -	0.5*	(0.5)#	(0.1)#
01-02	0.05#	01-02 -	0.4*	0.1#	-
02-03	-0.05#	02-03 (0.5)#	0.3	0.2*	(0.0)#
03-04	-0.15#	03-04 0.4#	0.2*	0.2*	(0.2)#
04-05	-0.20#	04-05 (0.1)#	0.2*	-0.1*	(0.1)#
05-06		05-06 0.2*	0.2*	(-0.2)#	-
06-07		06-07 -	0.3*	-	-
07-08		07-08 0.2#	0.2#	-	-
08-09		08-09 (0.1)#	(0.3)#	-	-
09-10		09-10 (0.0)#	0.4*	-	-
10-11		10-11 -	0.5*	-	-
11-12		11-12 -	0.5*	-	-
12-13		12-13 -	0.7*	-	-
13-14		13-14 -	0.5*	-	-
14-15		14-15 -	(0.4)#	-	-
15-16		15-16 -	-	-	-
16-17		16-17 -	-	-	-
17-18		17-18 -	-	-	0.2#
18-19		18-19 -	(0.5)#	(0.3)#	(0.1)#
19-20		19-20 -	(0.5)#	(0.3)#	-
20-21		20-21 -	0.4*	0.3*	-
21-22		21-22 -	(0.5)#	0.6*	-
22-23	0.05#	22-23 -	0.5*	(0.6)#	-
23-24	0.05#	23-24 -	0.5*	(0.5)#	-

TABLE 6.19

MONTHLY MEDIAN

NORTHWAY - NOME

	1949						1950		
	Jul	Aug	Sep	Oct	Nov	Dec	Jan	Feb	Mar
00-01	1.20	1.00	0.70	-1.00	0.40	0.40*	0.70#	0.90	0.80.
01-02	0.90	0.60	0.70	0.00	0.30	0.65*	0.50#	0.65	0.80
02-03	0.60	0.70	0.50	-1.00	0.15	0.40*	0.30*	0.50	0.70
03-04	0.10	0.30	0.70	-1.00	0.10	0.50*	0.45*	0.70	0.70
04-05	-1.00	0.00	0.70	0.00	0.00	0.50*	0.25*	0.70	0.60
05-06	-1.00	0.00	0.40	0.00	0.00	0.50*	0.05*	0.95	0.90
06-07	-1.00	-1.00	0.00	-1.00	0.00	0.40*	0.40*	1.10	0.60
07-08	-1.00	-1.00	-1.00	-1.00	0.00	0.30*	-1.00*	0.30	0.10
08-09	-1.00	-1.00	-1.00	-1.00	-1.00	0.50*	-1.00*	-1.00	-1.00
09-10	-1.00	-1.00	-1.00	-1.00	-1.00	0.30*	-1.00*	-1.00	-1.00
10-11	-1.00	-1.00	-1.00	-1.00	-1.00	-0.15*	-1.00*	-1.00	-1.00
11-12	-1.00	-1.00	-1.00	-1.00	-1.00	-1.00*	-1.00*	-1.00	-1.00
12-13	-1.00	-1.00	-1.00	-1.00	-1.00	-1.00*	-1.00*	-1.00	-1.00
13-14	-1.00	-1.00	-1.00	-1.00	-1.00	-0.40*	-1.00*	-1.00	-1.00
14-15	-1.00	-1.00	-1.00	-1.00	-1.00	-0.20*	-1.00*	-1.00	-1.00
15-16	-1.00	-1.00	-1.00	-1.00	-1.00	-0.10*	-1.00*	-1.00	-1.00
16-17	-1.00	-1.00	-1.00	-1.00	-1.00	0.20*	-1.00*	-1.00	-1.00
17-18	-1.00	-1.00	-1.00	-1.00	-1.00	0.10*	-1.00*	-1.00	-1.00
18-19	-1.00	-1.00	-1.00	-1.00	0.00	0.10*	-1.00*	0.10	0.10
19-20	-1.00	-1.00	-1.00	-0.30	0.10	0.10*	-0.50*	0.20	0.45
20-21	-1.00	0.00	0.45	0.00	0.10	0.20*	-1.00*	0.70	0.20
21-22	0.10	0.00	0.80	0.00	0.00	0.30*	-1.00*	0.60	0.50
22-23	0.35	0.50	0.90	0.00	0.00	0.20*	0.05*	0.70	0.70
23-24	0.95	1.00	0.70	0.00	0.20	0.45*	0.50*	0.60	0.60

4095 kc

E-W Long Path 4 mc

Apr	May	Jun	Jul	Aug	Sep	Oct	Nov	Dec
0.70	0.60	0.60	1.00	1.25	0.60*	0.45#	0.70#	0.50#
0.55	0.60	0.70	0.90	1.10	0.70*	0.40*	0.60#	0.65#
0.20	0.40	0.70	0.80*	1.20	0.35*	0.40*	0.60*	0.60*
0.45	0.40	0.70	0.65*	1.10	0.30*	0.50*	0.50*	0.70*
-0.30	0.15	0.50	0.30	0.80	0.30	0.50	0.00*	0.40*
0.20	-0.30	0.10	0.00	0.65	-0.10	0.40*	-1.00*	0.50*
0.40	-0.50	-0.20	-0.05	0.30	0.05*	-0.10*	0.50*	0.85*
-1.00	-1.00	-1.00	-1.00	-1.00	-1.00	-1.00*	0.00*	0.35*
-1.00	-1.00	-1.00	-1.00	-1.00	-1.00	-1.00*	-1.00*	0.30*
-1.00	-1.00	-1.00	-1.00	-1.00	-1.00	-1.00	-1.00*	0.20*
-1.00	-1.00	-1.00	-1.00	-1.00	-1.00	-1.00	-1.00*	-0.05*
-1.00	-1.00	-1.00	-1.00	-1.00	-1.00	-1.00	-1.00	-0.20*
-1.00	-1.00	-1.00	-1.00	-1.00	-1.00	-1.00	-1.00	-0.40*
-1.00	-1.00	-1.00	-1.00	-1.00	-1.00	-1.00	-1.00	-0.15*
-1.00	-1.00	-1.00	-1.00	-1.00	-1.00	-1.00	-1.00	0.00*
-1.00	-1.00	-1.00	-1.00	-1.00	-1.00	-1.00	-1.00	0.10
-1.00	-1.00	-1.00	-1.00	-1.00	-1.00	-1.00	-1.00	0.20*
-1.00	-1.00	-1.00	-1.00	-1.00	-1.00	-1.00	-1.00	0.30*
-1.00	-1.00	-1.00	-1.00	-1.00	-1.00	-0.50	0.00*	0.60*
0.30	-1.00	-1.00	-1.00	-0.45	0.00	-0.20	0.35*	0.40#
-1.00	-1.00	-0.20	-0.20	-1.00	0.40	0.00	0.00*	0.30*
0.20	0.00	0.20	0.30	0.40	0.50	0.20*	0.00*	0.20*
0.30	0.30	0.35	0.50	0.80	0.50	0.65#	0.10*	0.40*
0.40	0.40	0.50	0.70	1.00	0.60	0.70#	0.60#	0.55*

TABLE 6.20

MONTHLY MEDIAN

NORTHWAY - NOME

1954

	Jan	Feb	Mar	Apr	May	Jun	Jul	Aug
00-01	0.25	-0.20	-0.40		0.60	0.80	0.30	0.70
01-02	0.40	0.00	-0.30		0.60	0.80	0.90	0.40
02-03	0.20	-0.20	-0.40		0.50	0.40	0.40	0.40
03-04	0.00	-0.30	-0.40		0.30	0.30	0.30	0.20
04-05	0.30	0.00	-0.40		0.20	0.20	0.30	0.20
05-06	0.30	0.00	-0.50*		0.00	0.00	0.10	0.10
06-07	-0.10	0.00*	-0.35*		-0.20	-0.30	-0.20	-0.10
07-08	-0.10	-0.05*	-0.40*		-0.50	-0.50	-0.30	-0.30
08-09	0.20	-0.10*	-0.50*		-1.00*-0.50	-0.50	-0.50	-0.40
09-10	0.10	-0.15*	-		(-1.00)#-0.50#	-0.50#	-0.50*-0.50	-
10-11	0.00	-0.40*	-		-	-	(-0.55)#	-
11-12	-0.45	-	-		-	-	-	-
12-13	-0.50	-	-		-	-	-	-
13-14	-1.00	-	-		-	-	-	-
14-15	-1.00	-	-		-	-	-	-
15-16	-0.10	(-1.00)#	-		-	-	-	-
16-17	-0.10	(-1.00)#	-		-	-	(-1.00)#	-
17-18	-0.30	(-0.40)#	(-1.00)#		-1.00#	-0.50*	-0.50*-0.55#	-
18-19	-0.10	-0.20*	-		-1.00*-0.40	-0.40	-0.40*-0.3*	-
19-20	-0.30	(-0.30)#	-0.40*		-0.25*-0.30	-0.30	-0.20	-0.30
20-21	-0.30	-0.30#	-0.50*		0.00	0.00	0.00	0.10
21-22	-0.20	-0.40*	-0.40		0.15	0.20	0.20	0.10
22-23	0.00	-0.25	-1.00		0.30	0.40	0.40	0.30
23-24	0.15	-0.20	-0.35		0.50	0.55	0.55	0.55

4095 kc

E-W Long Path 4 mc

1955

Sep	Oct	Nov	Dec	Jan	Feb	Mar	Apr	May	Jun
0.30	0.10	0.50			0.55	-	1.3#	1.4*	0.3*
0.35	0.10	0.50			0.70	-	1.1#	1.4*	0.8*
0.10	0.10	0.20			0.30	-	1.0#	1.1*	0.6*
-0.05	0.10	0.30			0.10	-	1.0#	0.9	0.4*
-0.10	0.00	0.20			0.10	-	1.1#	0.7	0.2*
-0.20	-0.10*	0.20			0.00	-	0.6#	0.3*	0.0*
-0.30	0.00*	0.10			0.00	-	0.4*	0.1#	-0.1*
-0.35#	-0.30*	0.30			0.15	-	0.2#	-	(-0.2)#
-0.40)#	0.00*	0.20			0.20	-	0.1#	-	-
-	(-0.30)#	0.10			0.10*	-	-	-	-
-	-	0.05*			0.00*	-	-	-	-
-	-	-0.10*			-0.30#	-	-	-	-
-	-	0.10*			-0.50#	-	-	-	-
-	-	-0.10*			-	-	-	-	-
-	-	-0.10*			-	-	-	-	-
-	(-0.50)#	0.20			-	-	-0.2#	-	-
-	(-0.10)#	0.50			-	-	0.1#	-	-
-0.35#	0.00*	0.40			-	-	0.3#	-	-
-0.20#	0.10	0.30			-	-	0.7#	0.0#	-
-0.20*	0.10	0.00			-	0.8#	1.0*	0.2#	(0.1)#
-0.20	0.40	-0.10			-	1.0#	0.6*	0.3*	0.2*
0.00	0.10	0.15			-	-	0.7*	0.9	0.4*
0.00	0.00	0.20			-	-	1.0*	1.1	0.6
0.00	0.10	0.30			-	-	1.5*	1.4	0.7

TABLE 6.21

MONTHLY MEDIAN

NORTHWAY - NOME

	1949		1955
	June		July
00-01	0.25*	00-01	1.3
01-02	0.40*	01-02	1.1
02-03	0.00*	02-03	1.1
03-04	0.00*	03-04	0.8
04-05	-1.00*	04-05	0.6
05-06	-1.00*	05-06	0.3
06-07	-1.00*	06-07	0.1*
07-08	-1.00*	07-08	-0.1*
08-09	-1.00*	08-09	-
09-10	-1.00*	09-10	-
10-11	-1.00*	10-11	-
11-12	-1.00*	11-12	-
12-13	-1.00*	12-13	-
13-14	-1.00*	13-14	-
14-15	-1.00*	14-15	-
15-16	-1.00*	15-16	-
16-17	-1.00*	16-17	-
17-18	-1.00*	17-18	-
18-19	-1.00*	18-19	(0.1)#
19-20	-1.00*	19-20	0.0*
20-21	0.00*	20-21	0.3
21-22	0.50*	21-22	0.6
22-23	0.75*	22-23	0.8
23-24	0.60*	23-24	1.2

4095 kc

Long Path E-W

4 mc

Aug	Sept	Oct
1.3	0.8*	(1.0)#
1.2	0.8#	1.0#
1.1	0.8*	(1.0)#
1.0*	0.6*	0.8*
0.8*	0.7*	0.8*
0.6	0.7#	0.9*
0.5*	(0.3)#	1.1*
0.1*	(0.4)#	(0.8)#
-	-	(0.6)#
-	-	-
-	-	-
-	-	-
-	-	-
-	-	-
-	-	(0.2)#
-	-	(0.6)#
-	-	(0.9)#
0.2*	0.2*	(1.0)#
0.5*	0.6*	1.1*
0.7*	0.8*	1.2*
1.0	0.6	1.2*
1.2	0.6*	0.8*
1.4	0.8*	(1.2)#

TABLE 6.22

MONTHLY MEDIAN

ANCHORAGE - PT. B

	1949						1950	
	Jul	Aug	Sep	Oct	Nov	Dec	Jan	Feb
00-01	0.40	0.35	0.30#	-0.30	-0.50	0.20	0.25*	0.00*
01-02	0.45	1.00	0.60#	-0.40	-0.45	0.00	0.05*	-1.00*
02-03	0.20	0.30	0.60#	-0.40	-0.35	0.20	0.05*	-0.20*
03-04	0.00	0.00	0.60#	-0.30	-0.40	0.30	0.45*	-0.05*
04-05	-0.20	-1.00	0.60#	-0.05	-0.35	0.40	0.75*	0.20*
05-06	-0.40	-0.35	0.50#	-0.20	-0.30	0.30	0.10*	0.10*
06-07	-1.00	-1.00	0.10*	-0.30	-0.30	0.30	0.20*	0.30*
07-08	-1.00	-1.00	-0.30*	-1.00	-1.00	0.15	0.10*	0.10*
08-09	-1.00	-1.00	-1.00*	-1.00	-1.00	0.05	0.10*	-0.25*
09-10	-1.00	-1.00	-1.00*	-1.00	-1.00	-0.15	0.20*	-1.00*
10-11	-1.00	-1.00	-1.00*	-1.00	-1.00	-0.45	-0.20*	-1.00*
11-12	-1.00	-1.00	-1.00*	-1.00	-1.00	-0.45	-0.40*	-1.00*
12-13	-1.00	-1.00	-1.00*	-1.00	-1.00	-0.40	-0.40*	-1.00*
13-14	-1.00	-1.00	-1.00*	-1.00	-1.00	-0.50	-1.00*	-1.00*
14-15	-1.00	-1.00	-1.00*	-1.00	-1.00	-0.25	-1.00*	-1.00*
15-16	-1.00	-1.00	-0.40*	-1.00	-0.45	-0.10	-0.30*	-0.40*
16-17	-1.00	-1.00	-0.30*	-1.00	-0.50	-0.05	0.20*	-0.15*
17-18	-1.00	-1.00	0.10*	-0.40	-0.20	0.10	0.35*	0.20*
18-19	-0.45	-1.00	0.35*	-0.15	0.00	0.25	0.25*	0.10*
19-20	-0.20	-1.00	0.65*	0.05	0.05	0.35	0.50*	0.45*
20-21	0.00	-0.20	0.50*	0.00	0.05	0.40	0.55*	0.70*
21-22	0.20	0.50	0.75*	-0.05	-0.10	0.45	0.60*	0.50*
22-23	0.40	0.50	0.50*	-0.20	-0.40	0.40	0.50*	0.30*
23-24	0.40	0.40	0.35*	-0.10	-0.30	0.30	0.30*	0.00*

ARROW

4240 kc

S-N Long Path 4 mc

Mar	Apr	May	Jun	Jul	Aug	Sep	Oct	Nov	Dec
0.10	0.30	-0.10	-0.10	-0.35	0.20	0.30	-1.00	-0.30*	-1.00
-0.10	-0.20	-0.20	-0.05	-0.20	0.10	0.05	-1.00	-0.30*	-1.00
0.20	-0.30	-0.05	-0.20	-0.20	0.20	0.10*	-1.00	-0.20*	-1.00
0.20	-0.05	-0.20	-0.30	-0.40	0.40	0.10	-1.00	-0.30	-0.30
0.15	0.10	-1.00	-0.50	-1.00	0.45	0.10	-1.00	-0.25	-0.20
0.15	-0.10	-1.00	-0.50	-1.00	0.00	-0.55	-1.00	-0.40	-0.35
-0.20	-0.40	-1.00	-0.50	-1.00	-0.25*	-1.00	-1.00	-1.00	-0.40
-1.00	-1.00	-1.00	-0.50	-1.00	-1.00*	-1.00	-1.00	-1.00	-1.00
-1.00	-1.00	-1.00	-0.50	-1.00	-1.00*	-1.00	-1.00	-1.00	-1.00
-1.00	-1.00	-1.00	-0.50	-1.00	-1.00*	-1.00	-1.00	-1.00	-1.00
-1.00	-1.00	-1.00	-0.50	-1.00	-1.00*	-1.00	-1.00	-1.00	-1.00
-1.00	-1.00	-1.00	-0.50	-1.00	-1.00*	-1.00	-1.00	-1.00	-1.00
-1.00	-1.00	-1.00	-0.50	-1.00	-1.00*	-1.00	-1.00	-1.00	-1.00
-1.00	-1.00	-1.00	-0.50	-1.00	-1.00*	-1.00	-1.00	-1.00	-1.00
-1.00	-1.00	-1.00	-0.50	-1.00	-1.00*	-1.00	-1.00	-1.00	-1.00
-1.00	-1.00	-1.00	-0.50	-1.00	-1.00*	-1.00	-1.00	-1.00	-1.00
-0.35	-1.00	-1.00	-0.50	-1.00	-1.00*	-1.00	-1.00	-1.00	-0.30
-0.20	-1.00	-1.00	-0.50	-1.00	0.00*	-1.00	-1.00	-0.50	-0.05
0.00	-1.00	-1.00	-0.50	-1.00	0.10*	-0.40	-0.45	-0.30	-0.20
0.30	-0.30	-1.00	-0.50	-1.00	0.10	0.05	-0.30	-0.35	-0.20
0.40	-0.10	-1.00	-0.30	-1.00	0.30	0.10	-0.40	-0.25	-0.10
0.20	0.20	-0.20	-0.10	-0.30	0.50	0.00	-0.40	-0.20	-0.10
0.00	0.25	0.00	0.00	0.10	0.30	-0.15	-1.00	-0.30	-0.30
-0.15	0.40	0.20	-0.05	-0.20	0.20	0.05	-1.00	-0.40	-0.50

TABLE 6.23

MONTHLY MEDIAN

SHEEP MOUNTAIN - PT. BARROW

4240 kc

Long Path

4 mc

	1954												1955						
	Jan	Feb	Mar	Apr	May	Jun	Jul	Aug	Sep	Oct	Nov	Dec	Jan	Feb	Mar	Apr	May	Jun	
00-01	-0.40	-0.50*	-0.25	0.30	0.30	0.25	0.20	-0.30	-0.25*	-0.40	-0.40	-0.30	-	-	-	-	0.3*	(0.1)#	
01-02	-0.40*	(-0.50)#	-0.30	0.40	0.40	0.20	-0.20	-0.30	-0.40	-0.30	-0.40	-0.20	-	-	-	-	0.4#	0.2#	(0.1)#
02-03	-0.40	-0.50*	-0.25	0.50	0.50	0.20	-0.20	-0.05	-0.30	-0.35	-0.45	-0.30	0.0#	-	-	-	0.4#	0.2#	-
03-04	-0.40*	(-0.45)#	-0.30	0.50	0.50	0.10	-0.30	-0.40	-0.40*	-0.40	-0.40	0.00	0.0#	-	-	-	0.2#	0.2*	-
04-05	-0.40*	-	-0.20	0.40	0.40	0.10	-0.15	0.00	-0.40*	-0.40	-0.40	0.00	-	-	-	0.1#	-	-	-
05-06	-0.40*	(-0.45)#	-0.20	0.05	-0.10	0.00*	0.00*	-0.50	-0.30*	-0.40	-0.35*	-0.20	-	-	-	-	-	-	-
06-07	-0.40	-0.50*	-0.10	-0.10	-0.10	-0.10	-0.30	-0.30	-0.30#	-0.30	-0.30	-0.30	-	-	-	-	0.2#	-	-
07-08	-0.30	-0.50*	-0.30	-0.10	-0.10	-0.20	-0.30	-1.00	-0.30#	-0.40	-0.30	-0.20	-	-	-	-	0.3#	-	-
08-09	-0.30	-0.30*	-0.10	-0.20	-0.20	-0.30	-0.20*	-0.50	0.10	-0.30	-0.05	0.00	-	-	-	-	-	-	-
09-10	-0.20	-0.50*	-0.40	-0.20	-0.20	-0.30	0.00*	-1.00	-0.10*	-0.40	-0.20	0.10	0.8#	-	-	-	-	-	-
10-11	-0.40	-0.40*	-0.20	-0.20	-0.20	-0.30	-0.40*	-1.00	-0.20	-0.40	-0.30	0.05	-	-	-	-	-	-	-
11-12	-0.40*	-0.55*	-0.30	-0.30	-0.30	-0.35	-0.30*	-1.00	-0.20	-0.40	-0.30	0.00	-	-	-	-	-	-	-
12-13	-0.30*	-1.00*	-0.40	-0.40	-0.40	-0.40	-0.30*	-1.00	-0.40*	-0.40	0.40	-0.10	-	-	-	-	-	-	-
13-14	-0.30	-0.50*	-0.25	-0.30	-0.30	-0.30	-0.20*	-1.00	0.20	-0.40	-0.20	0.10	-	-	-	-	-	-	-
14-15	-0.20	-0.50*	-0.25	-0.20	-0.20	-0.30	-0.20*	-1.00	0.00	-0.30	-0.20	0.20	-	-	-	-	-	-	-
15-16	-0.15	-0.50*	-0.25	-0.20	-0.20	-0.40	-0.10*	-0.50	-0.05	-0.30	-0.20	0.15	-	-	-	-	-	-	-
16-17	-0.20	-0.50*	-0.20	-0.20	-0.20	-0.30	-0.30	-0.50	-0.10	-0.25	0.05	0.15	-	-	-	-	-	-	-
17-18	-0.30	-0.40*	-0.15	0.00	0.00	0.30	0.00*	-0.50	-0.30	0.05	0.10	-0.20	-	-	-	-	-	-	-
18-19	-0.40	-0.45*	0.05	0.10	0.10	0.10	-0.10	-0.10	-0.05*	-0.30	-0.30	-0.40*	-	-	-	-	0.2#	-	-
19-20	-0.40	-0.50*	0.10	0.40	0.40	0.20	0.10	0.00	0.00	-0.25	-0.30	-0.40	-	-	-	-	0.5#	0.0#	-
20-21	-0.30	-0.45*	0.20	0.40	0.40	0.40	0.10	0.10	0.00	-0.20	-0.40	-0.30	-	-	-	-	0.5#	0.2*	(0.0)#
21-22	-0.30	-0.40*	0.10	0.40	0.40	0.70	0.20	0.10	-0.10	-0.10	-0.30	-0.10	-0.1#	-	-	-	0.6#	0.2*	0.1*
22-23	-0.30*	-0.40*	0.00	0.50	0.50	0.70	0.20	0.10	-0.10	-0.35	-0.40	-0.10	-	-	-	-	0.8#	0.2*	0.1*
23-24	-0.30	-0.50*	-0.20	0.55	0.55	0.50	0.10	0.10	-0.20	-0.40	-0.40	-0.10	-	-	-	-	0.3#	0.2*	0.1#

TABLE 6.24

MONTHLY MEDIAN

SHEEP MOUNTAIN

	1955			
	Jul	Aug	Sep	Oct
00-01	0.4*	0.3*	(0.10)#	(0.0)#
01-02	0.4*	0.4*	0.15#	(-0.1)#
02-03	(0.2)#	0.2*	0.20*	(0.0)#
03-04	(0.1)#	0.2*	0.20*	(0.2)#
04-05	-	0.2*	0.20*	(0.2)#
05-06	-	-0.1#	(0.10)#	(0.2)#
06-07	-	(0.0)#	-	(0.3)#
07-08	-	(0.3)#	-	(0.2)#
08-09	-	-	-	(-0.1)#
09-10	-	-	-	-
10-11	-	-	-	-
11-12	-	-	-	-
12-13	-	-	-	-
13-14	-	-	-	-
14-15	-	-	-	-
15-16	-	-	-	-
16-17	-	-	-	-
17-18	-	(-0.1)#	-	(0.3)#
18-19	-	0.1*	0.10#	0.5#
19-20	(0.2)#	0.2*	0.30*	0.5*
20-21	0.2*	0.5*	0.20*	0.3*
21-22	0.4*	0.7*	0.10*	(0.6)#
22-23	0.5*	0.6*	(0.20)#	(0.3)#
23-24	0.4*	0.5*	(0.10)#	(0.0)#

- PT. BARROW

4240 kc

Long Path

4 mc

TABLE 6.25

MONTHLY MEDIAN

NORTHWAY - NOME

7940 kc

7940 kc (1 July 1949 to 12 July 1950)

7865 kc (12 July to 1 Jan 1951)

E-W Long Path 8 mc

	1949				1950													
	Jul	Aug	Sep	Oct	Nov	Dec	Jan	Feb	Mar	Apr	May	Jun	Jul	Aug	Sep	Oct	Nov	Dec
00-01	1.90	1.50	1.10*		0.85*	1.00	0.20#	-0.25	0.60	1.00	1.00	1.05	0.95	0.70*	0.50*	-	-	-
01-02	1.80	1.50	0.90*		0.70*	1.20	0.40#	0.10	0.80	0.80	1.10	1.10	1.10	0.70*	0.45*	-	-	-
02-03	1.75	1.35	0.75*		0.90*	1.25	0.20*	0.20	0.90	0.60	1.20	1.20	1.00*	0.70*	0.40*	-	-	-
03-04	1.75	0.75	0.90*		0.75*	1.10	-0.30*	0.10	0.70	0.80	1.20	1.20	1.05*	0.50*	0.40*	-	0.50#	-
04-05	1.65	1.10	0.90*		0.70*	1.00	-0.25*	-0.15*	0.60	0.90	1.25	1.15	1.05*	0.45*	0.40	-	0.80#	-
05-06	1.45	1.10	0.80*		0.90#	1.10	-0.65*	-0.15*	0.70*	0.60	1.05	1.20	1.00*	0.30*	0.00*	-	0.80#	-
06-07	1.25	0.85	0.65*		1.10#	1.10	-0.35*	-0.40*	0.40*	1.00	0.90	1.10	0.90	0.60*	-0.10*	-	0.70#	-
07-08	0.95	0.45	0.90*		0.70*	0.90	-1.00*	-0.70	0.60*	1.00	0.70	0.90	0.90	1.00*	-0.10*	(-1.00)#	-	-
08-09	0.80	0.40	0.75*		0.60*	1.20	-0.15*	0.20	0.80	0.60	0.60	0.60	0.70	0.70*	-0.10*	(-1.00)#	-	-
09-10	0.75	0.40	0.05*		0.30*	1.40	0.30*	0.05	0.70	0.10	0.45	0.50	0.30*	0.65*	-1.00*	(-1.00)#	-	1.10#
10-11	0.55	0.20	0.05*		0.45*	1.30	-0.10*	-0.15	0.60	-0.10	0.20	0.40	0.30*	0.70*	-0.50*	(-1.00)#	-	0.95*
11-12	0.60	0.00	-1.00*		0.55#	1.30	-0.60*	0.30	0.60	-0.20	0.10	0.30	0.25	0.50*	0.00*	(-1.00)#	-	1.00*
12-13	0.55	0.00	-1.00*		0.50#	1.20	-0.10*	0.10	0.75	-0.10	0.05	0.40	0.30	0.60*	-0.50*	(-1.00)#	-	0.80*
13-14	0.50	0.00	-1.00		0.70*	1.35	0.10*	0.20	0.70	0.00	0.00	0.40	0.10	0.60*	-1.00*	-	1.50#	0.80*
14-15	0.55	0.10	-1.00		0.90*	1.40	0.60*	-0.10	0.40	0.00	0.10	0.40	0.10	0.50*	-1.00*	(-1.00)#	1.80#	0.95*
15-16	0.55	0.00	0.15*		0.70*	1.50	0.80*	-0.20	0.80	0.40	0.00	0.35	0.20	0.55*	0.50*	(0.45)#	1.10#	1.10*
16-17	0.65	0.10	0.30*		0.90*	1.55	0.75*	-0.40	0.90	0.60	0.10	0.40	0.10	0.70*	-0.20*	(0.50)#	1.20#	1.20#
17-18	0.70	0.30	0.55*		1.00*	1.35	0.90*	0.60	0.60	0.80	0.40	0.45	0.30	0.80*	0.20*	(0.70)#	1.30#	-
18-19	1.10	0.60	0.20*		1.20*	1.10	0.80*	0.80	1.10	0.90	0.45	0.40	0.40	1.00*	0.10*	-	0.50#	-
19-20	1.25	0.60	0.90*		1.15*	1.10	0.30*	0.50	1.20	0.60	0.50	0.60	0.60	1.10*	0.85*	-	-	-
20-21	1.40	0.90	0.95*		1.00*	0.90	-0.30*	0.00	1.00	0.90	0.50	0.70	0.65	1.10*	0.65*	-	-1.00#	-
21-22	1.45	1.00	0.70*		1.20*	1.10*	-0.30*	-1.00	0.90	1.00	1.00	0.75	0.70*	0.95*	0.80*	-	-1.00#	-
22-23	1.65	1.05	0.65*		1.20#	0.95	0.45*	-0.20	0.50	1.10	1.05	1.00	0.85*	1.00*	0.70*	-	-	-
23-24	1.90	1.10	0.90*		1.10*	1.20	0.50*	-0.20	0.60	1.20	0.90	0.90	1.00*	0.80*	0.70*	-	-	-

TABLE 6.26

MONTHLY MEDIAN

NORTHWAY - NOME

1954

	Jan	Feb	Mar	Apr	May	Jun	Jul	Aug
00-01	-1.00	-1.00*	-1.00*		0.55	0.50	0.20	0.30
01-02	-0.45	-1.00*	-1.00*		0.50	0.70	0.20	0.30
02-03	-0.30	-1.00*	-1.00*		0.45	0.65	0.30	0.25
03-04	-0.20	-1.00*	-0.50*		0.25	0.80	0.55	0.20
04-05	-0.10	-0.50*	-0.50*		0.00	0.60	0.35	0.00
05-06	-0.15	-0.50*	-0.50*		0.05	0.90	0.80	0.30
06-07	-0.30	-0.50*	(-0.45)#		0.50	0.80	0.80	0.50
07-08	-0.50	(-0.40)#	(0.00)#		0.20	0.60	0.70	0.50
08-09	-1.00	(-1.00)#	(-0.50)#		-0.10	0.30	0.50	0.30
09-10	-0.20	-0.20*	0.00#		-0.50	0.20	0.30	0.20
10-11	0.40	-1.00*	0.10#		-0.75	0.10	0.20	0.15
11-12	0.30	-0.10*	-1.00*		-1.00	0.00	0.10	0.10
12-13	0.20	-0.35*	-1.00*		-1.00	0.10	0.10	0.10
13-14	0.20	-0.20*	-1.00*		-1.00	0.10	0.10	0.20
14-15	0.30	-0.50*	-1.00*		-1.00	0.10	0.10	0.20
15-16	0.40	-0.60*	-0.30*		-0.45	0.30	0.20	0.15
16-17	-0.05	0.00*	-0.30#		0.00	0.40	0.30	0.15
17-18	-1.00	-0.20*	-0.15*		0.00	0.40	0.50	0.30
18-19	-1.00	-	-1.00*		0.30	0.60	0.65	0.15
19-20	-1.00	-	(-1.00)#		0.35	0.80	0.60	0.10
20-21	-1.00*	-	(-1.00)#		0.20	0.70	0.60	0.00
21-22	-1.00*	-0.20#	-0.50*		0.00	1.00	0.60	0.00
22-23	-1.00	-0.30#	-1.00*		-1.00	0.85	0.50	0.10
23-24	-0.50	-0.40#	-1.00		-1.00	0.70	0.40	0.15

7580 kc

Long Path -W

8 mc

1955

Sep	Oct	Nov	Dec	Jan	Feb	Mar	Apr	May	Jun
0.10	-0.10	-0.25			0.4*	-	-	(1.4)#	-
0.20	-0.10	0.00			0.5#	-	-	-	-
0.15	0.05	0.00			0.6#	-	-	(1.5)#	-
0.05	0.20	-0.10			0.5#	-	-	-	(1.3)#
0.00	-0.30*	0.10			0.4#	-	-	1.0*	1.0*
-0.35*	-0.30*	-0.10			-	-	-	1.5#	0.0*
-0.50#	-0.20*	-0.30*			-	-	-	1.4*	0.7*
-0.50#	-0.05#	-0.30*			-	-	1.4#	1.1*	0.6*
-0.10*	0.30*	-0.30			-	1.0#	1.3*	0.7*	0.4
-0.10*	0.70*	0.00			0.9#	0.7#	1.1*	0.8*	0.3*
0.00*	0.40*	0.10			0.6*	0.9#	1.0*	0.5*	0.3*
-0.10*	0.30*	0.10			0.7#	0.6#	1.0*	0.5	0.2*
-0.20	0.50*	0.10			0.6*	0.8#	1.1*	0.5*	0.2*
0.00	0.30	0.10			0.7#	0.6#	1.2*	0.4*	0.0*
0.20	0.20	0.10			0.8#	1.0#	1.2*	0.4*	0.1*
0.20	0.20*	0.20			0.8*	1.4#	1.3*	0.5*	0.1*
0.20*	0.20	0.10			1.0*	0.8#	1.3*	0.5*	0.3*
-0.15*	0.60*	-0.30*			1.1*	-	1.6*	0.8	0.4*
-0.50*	0.20*	-0.35*			1.0#	1.2#	1.7*	0.3*	0.8*
-0.10*	0.00*	-0.20*			-	-	1.6#	1.0*	1.2*
0.00	0.00*	-0.25*			-	-	1.8#	1.1*	1.0*
0.15*	-0.25*	-0.30*			-	-	1.1*	1.2*	1.2*
0.25	-0.20*	-0.30*			-	-	0.6*	1.1	0.9
0.00	0.00	-0.05*			-	-	0.6#	1.1*	0.8*

TABLE 6.27 MONTHLY MEDIAN

NORTHWAY - NOME

7940 kc	1949		1955
	June		Jul
00-01	1.75	00-01	1.0*
01-02	1.75*	01-02	0.9*
02-03	1.50	02-03	0.8*
03-04	1.70	03-04	0.8*
04-05	1.60	04-05	0.3
05-06	1.30	05-06	1.0
06-07	1.15	06-07	0.9
07-08	1.05	07-08	0.3
08-09	0.80	08-09	0.5
09-10	0.75	09-10	0.5*
10-11	0.60	10-11	0.4*
11-12	0.45	11-12	0.3*
12-13	0.65	12-13	0.2*
13-14	0.70*	13-14	0.1*
14-15	0.70*	14-15	0.3
15-16	0.50	15-16	0.2
16-17	0.60	16-17	0.3
17-18	0.90	17-13	0.5
18-19	1.20	18-19	0.7*
19-20	1.30	19-20	1.1*
20-21	1.45	20-21	1.0*
21-22	1.70	21-22	1.1*
22-23	1.65	22-23	1.0
23-24	1.60*	23-24	1.1

Long Path E-W

8 mc

7580 kc

Aug	Sep	Oct
1.0*	0.5#	(0.4)#
0.8*	(0.5)#	(0.6)#
0.7*	0.4*	(0.6)#
0.8*	0.5*	(0.4)#
0.8*	0.5*	(0.4)#
0.9*	(0.5)#	(0.4)#
0.8	(0.5)#	(0.4)#
0.8	0.7*	(0.9)#
0.7	0.8	(1.2)#
0.6*	0.8*	(1.1)#
0.6*	0.5*	(1.0)#
0.4*	0.5	(0.4)#
0.4*	0.4	(0.6)#
0.4*	0.5	(0.6)#
0.3*	0.5	0.7*
0.3	0.6	0.6#
0.4	0.8	0.8*
0.7*	0.8	(1.1)#
0.8*	1.0*	(1.0)#
-	(1.3)#	(1.5)#
(0.5)#	(1.1)#	(1.3)#
(1.4)#	0.8#	-
1.1*	0.4*	(0.8)#
(0.8)#	0.4*	(0.5)#

TABLE 6.28

MONTHLY MEDIAN

ANCHORAGE - PT.

	1949						1950
	Jul	Aug	Sep	Oct	Nov	Dec	Jan
00-01	1.30	0.70#	(1.30)#	0.50*	0.45#	0.80*	0.60*
01-02	1.20	0.80*	(1.10)#	0.45*	(0.60)#	0.60*	0.30*
02-03	1.20	0.95*	(0.95)#	0.50*	(0.70)#	0.60*	0.20*
03-04	1.10	-0.05*	(1.60)#	0.40*	(0.70)#	0.70*	0.25*
04-05	1.10	-0.35*	(1.55)#	0.60*	0.90#	0.80*	0.40*
05-06	1.00	-1.00*	(1.30)#	0.60*	(0.70)#	0.80	0.40*
06-07	0.85*	-1.00*	(1.55)#	0.90*	(0.65)#	0.80*	0.40*
07-08	0.75*	-0.45#	(1.40)#	0.85*	(0.90)#	0.70*	0.40*
08-09	0.60*	(-1.00)#	(1.30)#	0.50*	(1.00)#	0.80	0.50*
09-10	0.70*	(-1.00)#	1.10#	0.50*	(1.00)#	1.10	0.80*
10-11	0.55*	(-1.00)#	1.00*	0.40*	(0.90)#	1.00	0.55*
11-12	0.60*	(-1.00)#	0.65*	0.55*	0.70#	0.90	0.65*
12-13	0.35*	(-1.00)#	0.80*	0.45*	0.70#	0.95	0.55*
13-14	0.50*	(-1.00)#	0.85*	0.55*	0.70*	0.85	0.60*
14-15	0.60*	-	0.65#	0.65*	0.95*	0.90	0.70*
15-16	0.60*	(0.00)#	1.30*	0.70*	1.00*	1.10	0.85*
16-17	0.70*	(0.25)#	1.30*	0.80*	1.00*	1.05	1.10*
17-18	0.50*	(0.80)#	(1.45)#	0.80*	1.00*	1.00	1.20*
18-19	0.80	1.25*	(1.60)#	0.85	0.90*	1.00	0.50*
19-20	1.05	1.10*	(1.60)#	0.75	0.90*	0.90*	0.00*
20-21	1.00	1.45*	(1.80)#	0.70	0.70*	0.70*	0.30*
21-22	1.10	(0.90)#	(1.20)#	0.65	0.65*	0.80	0.50*
22-23	1.20	(0.65)#	(1.15)#	0.65*	0.45#	0.80	0.60*
23-24	1.20	0.55*	(1.25)#	0.60*	0.55#	0.80	0.55*

BARROW 7865 kc 7865 Changed to 7895 at 12:00 March 31, 1950
 7895 kc (1 April 1950 to 11 July 1950)
 7940 kc (11 July 1950 to 1 Jan 1951)
 S-N Long Path 8 mc

Feb	Mar	Apr	May	Jun	Jul	Aug	Sep	Oct	Nov	Dec
0.60*	0.85	0.60	0.45	1.10	0.40	0.60	0.20	-1.00*	-1.00	-1.00
0.95*	0.90	0.50	0.60	0.95	0.70	0.60	0.00	-0.50*	-1.00	-1.00
0.80*	0.70	0.30	0.75	1.15	0.40	0.40	0.00	-0.30	-1.00	-1.00
0.60*	0.80	0.70	0.70	1.10	0.60	0.30	-0.10	-0.40	-1.00	-1.00
0.80*	0.65	1.00	0.70	1.20	0.50	0.45	0.00	-0.20	-1.00	-1.00
0.90*	0.60	1.05	0.80	1.00	0.40	0.35	-0.20	-0.30	-1.00	-0.20*
0.90*	0.75*	1.10	0.00	1.00	0.50	0.30	-0.10	-1.00	-1.00*	-0.20*
0.85*	0.60*	0.60	0.20	0.60	0.40	0.35	-0.35	-1.00*	-1.00*	0.00
1.00*	0.60	0.40	0.20	0.50	0.40	0.25	-0.55	-0.50*	-1.00*	-0.50*
0.85*	0.90	0.10	0.15	0.50	0.45	0.20	-0.50	-0.55	-1.00*	-1.00
0.55*	0.80	-0.10	0.10	0.50	0.30	0.30	-0.40	-1.00	-1.00	-1.00
0.70*	0.70	0.00	0.00	0.50	0.35	0.30	-0.50	-1.00	-1.00	-1.00
0.80*	0.75	0.00	0.10	0.40	0.20	0.40	-0.40	-1.00	-1.00	-0.30*
0.90*	0.80	0.10	-0.05	0.45	0.20	0.30	-0.05	-1.00	-1.00	-0.45*
1.00*	0.90	0.20	0.05	0.50	0.20	0.30	-0.15	-0.75	-1.00	-0.50
1.10*	1.10	0.40	0.10	0.50	0.20	0.50	-0.50	-0.35	-1.00	0.00*
1.10*	1.15	0.55	0.10	0.60	0.30	0.70	0.20	-0.25	-1.00*	-1.00
1.30*	1.10	0.60	0.30	0.60	0.20	0.80	0.00	0.00	-1.00*	-0.20*
1.25*	1.20	0.70	0.40	0.70	0.30	0.70	0.20	0.30*	-1.00*	-1.00*
1.20	1.30	0.70	0.40	0.70	0.80	0.70	0.20	0.30	-1.00*	-0.30*
1.30*	0.95	0.70	0.50	1.00	0.85	0.80	0.30	0.20*	-1.00*	-0.15*
0.70*	1.00	0.75	0.80	1.00	0.75	0.80	0.40	0.00	-1.00*	0.10
0.55*	0.70	1.00	0.70	1.20	0.85	0.60	0.20	-0.20	-1.00	-0.15
0.40*	0.90	0.90	0.50	0.90	0.40	0.60	0.10	-1.00	-1.00	-0.25

TABLE 6.29 MONTHLY MEDIAN SHEEP MOUNTAIN - PT. BARROW 8 mc 7940 kc Long Path S-N
1954 1955

	Jan	Feb	Mar	Apr	May	Jun	Jul	Aug	Sep	Oct	Nov	Dec	Jan	Feb	Mar	Apr	May	Jun
00-01	-0.25	-0.20*	-0.20	0.10	0.15	0.05	0.10	0.10	0.10	0.00	0.25	0.20	0.10	-	-	0.15#	0.1*	0.5#
01-02	-0.30	-0.40*	-0.30*	0.10	0.00	0.05	0.10	-0.10	0.00	0.20	0.10	0.10	0.10	-	-	-	0.2*	0.6*
02-03	-0.30	-0.40*	-0.30	0.10	0.00	-0.10	-0.20	0.10	-0.10	0.05	0.00	0.00	0.00	-	-	-	0.4#	0.6#
03-04	-0.40*	(-0.40)#	-0.40*	0.20	0.05	0.10	-0.40*	0.00	-0.10	0.00	0.15	0.10	0.10	-	-	-	0.3*	(0.8)#
04-05	-0.30*	-0.40#	-0.40*	0.15	0.10	0.10	-0.35*	-0.25*	0.00	0.15	0.00	0.00	0.00	0.5#	-	-	0.2*	0.4#
05-06	-0.40	-0.40*	-0.40*	0.10	0.40	0.25	-0.10*	0.00*	-0.10	0.10	0.10	0.10	0.05	-	-	-	0.2*	0.4*
06-07	-0.30	-0.40*	-0.45*	0.30	0.40	0.20	0.10*	-0.20*	0.00	0.45	0.20	0.20	0.10	-	-	0.4#	0.4*	0.1*
07-08	-0.40	-0.40*	-0.35*	0.40	0.40	0.40	0.20	0.10	-0.10	0.40	0.50	0.50	0.20	-	-	0.3#	0.5*	0.3*
08-09	-0.35	-0.50	-0.40*	0.30	0.10	0.30	0.40	-0.15*	0.00	0.35	0.20	0.20	0.10	-	-	(0.4)#	0.8*	0.2*
09-10	-0.40	-0.40*	0.10*	0.20	0.05	0.20	0.10	0.20*	0.00	0.10	0.10	0.10	0.10	-	-	0.8#	0.7*	0.2*
10-11	-0.10	-0.50*	-0.30*	0.00	-0.10	0.10	0.10	0.20*	-0.10	0.20	0.45	0.20	0.20	1.1#	0.6#	0.5*	0.2*	0.1*
11-12	0.10	-0.50*	-0.40*	0.00	-0.10	0.10	0.05	0.30*	0.00	0.50	0.90	0.90	0.15	-	0.7#	0.4*	0.1*	0.0*
12-13	0.15	-0.20*	-0.20*	0.00	-0.10	0.00	0.20	0.20	-0.05	0.70	1.00	1.00	0.05	0.8#	0.6#	0.5*	0.3*	0.0*
13-14	0.20	-0.10*	-0.05*	0.00	-0.10	0.10	0.20	0.35*	0.00	0.80	1.05	1.05	0.25	-	0.7#	0.5#	0.3*	0.0*
14-15	0.25	-0.40	-0.20*	0.25	0.00	0.10	0.30	0.00	0.00	0.80	1.05	0.50	0.50	0.9#	-	0.8*	0.3*	0.2*
15-16	0.20	-0.35*	-0.40*	0.50	0.20	0.30	0.50	0.20	0.10	0.60	0.50	0.10	0.10	-	-	0.9*	0.2	0.1
16-17	-0.40	-0.30	-0.30*	0.50	0.50	0.50	0.40	-0.20	0.30	0.30	0.00	0.00	0.00	0.9#	-	0.9*	0.5	0.4
17-18	-0.50	-0.50	-0.40*	0.40	0.60	0.70	0.15	-0.10	0.20	0.20	0.10	-0.10	-0.10	-	-	0.8*	0.7	0.5
18-19	-0.40	-0.50	-0.30	0.30	0.70	0.60	0.00	-0.30	0.00	0.10	-0.10	-0.10	-0.10	-	0.7#	0.7*	0.6	0.7
19-20	-0.40	-0.45	0.00	0.40	0.50	0.50	0.10	0.15	0.00	0.15	-0.10	-0.10	-0.10	-	-	0.8*	0.6	0.7
20-21	-0.30	-0.25	0.10	0.10	0.50	0.40	0.00	0.45	0.20	0.10	-0.10	0.00	0.00	0.5#	-	0.2*	0.8	0.1
21-22	-0.20	-0.10	0.25	0.15	0.50	0.20	0.20	0.60	0.50	0.15	0.00	0.00	0.00	0.7#	-	0.2*	0.7*	0.6*
22-23	-0.30	-0.10	0.10	0.10	0.20	0.10	0.20	0.50	0.20	0.10	0.15	0.15	0.10	-	-	0.1*	1.0*	0.6*
23-24	-0.20	-0.20	-0.05	0.00	0.10	0.00	0.05	0.30	0.00	0.10	0.30	0.30	0.20	-	-	0.0#	1.1*	0.8*

TABLE 6.30

MONTHLY MEDIAN

8 mc

1955

Jul

00-01	0.2*
01-02	0.0*
02-03	0.2*
03-04	0.3*
04-05	0.3*
05-06	0.7*
06-07	0.7*
07-08	0.7
08-09	0.5
09-10	0.2
10-11	0.2
11-12	0.2*
12-13	0.1
13-14	0.2
14-15	0.3
15-16	0.4
16-17	0.5
17-18	0.5
18-19	0.8
19-20	1.0
20-21	0.8
21-22	0.7
22-23	0.5
23-24	0.3*

SHEEP MOUNTAIN - PT. BARROW

7940 kc Long Path S-N

Aug	Sep	Oct
0.3*	0.0*	(0.0)#
0.2*	0.0*	(0.1)#
0.2*	0.1*	(0.2)#
0.1*	0.0*	(0.3)#
0.0*	(0.1)#	-0.1*
0.2*	(0.2)#	-0.1*
0.8*	(0.0)#	(0.0)#
0.9*	0.3*	0.1*
0.6	0.3*	0.6*
0.4	0.4*	0.5*
0.4	0.4*	0.5*
0.4	0.4*	0.4*
0.3	0.4*	0.4*
0.4	0.2	0.4*
0.4	0.3	0.4*
0.5	0.4	0.4*
0.6	0.5	0.7*
0.7	0.4	0.9*
0.7	0.5*	0.8*
0.8	0.3*	0.6#
0.4	0.2*	(0.3)#
0.2	0.2	0.4*
0.2	0.2*	0.1*
0.2	0.0*	(0.1)#

TABLE 6.31

MONTHLY MEDIAN

NORTHWAY - NOME

	1949						1950		
	Jul	Aug	Sep	Oct	Nov	Dec	Jan	Feb	Mar
00-01	0.90	0.85	0.90	1.00	0.80	0.70	-0.10*	0.15	0.60
01-02	0.85	1.05	1.00	0.70	0.85	0.85*	0.20*	-0.05	0.60
02-03	0.90	0.85	1.00	0.60	0.65	0.85*	-0.10*	0.00	0.50
03-04	0.60	1.00	0.80	0.50	0.70	0.65*	-0.30*	-0.05	0.50
04-05	1.00	0.40	0.60	0.40*	0.60	0.80*	-0.05*	-0.15	0.50
05-06	0.80	0.35	0.50	0.45*	0.60	0.80*	-0.20*	-0.15	0.20
06-07	1.10	0.50	0.40	0.20*	0.50	0.70	-0.20*	0.10	0.20
07-08	1.30	0.65	0.50	0.35*	0.40	0.75*	-1.00*	0.00	0.20
08-09	1.45	1.15	0.40	0.80*	0.50	0.75*	-1.00*	-0.30	0.60
09-10	1.35	1.30	0.80	1.05*	1.10	1.00	0.00*	0.40	0.80
10-11	1.45	1.40	1.20	1.20*	1.20	1.45	0.00*	0.90	0.70
11-12	1.40	1.30	1.25	1.00*	1.35	1.40	-0.10*	0.40	1.00
12-13	1.40	1.25	1.35	1.25*	1.20	1.35	0.00*	0.70	1.35
13-14	1.30	1.20	1.35	1.35*	1.20	1.40	0.25*	1.00	1.50
14-15	1.40	1.20	1.20	1.40	1.20	1.50	0.10*	0.85	1.50
15-16	1.40	0.80	0.75	1.60	1.20	1.55	0.65*	0.75	1.40
16-17	1.20	0.50	0.40	1.25	1.30	1.65	0.70*	0.90	1.30
17-18	0.80	0.30	0.40	1.20	1.30	1.30	0.50*	1.00	1.40
18-19	0.00	0.45	0.50	0.90	0.90	0.70	0.00*	0.80	1.00
19-20	0.80	0.60	0.80	0.80	0.60	0.40*	-0.65*	0.05	1.20
20-21	0.90	0.70	1.00	0.75*	0.50	0.20*	1.00*	-0.10	0.80
21-22	0.80	0.60	0.80	1.05*	0.90	0.80*	0.20*	0.00	0.70
22-23	0.70	0.70	0.80	1.10*	0.95	1.00*	0.10*	0.25	0.60
23-24	0.80	0.80	0.70	1.00	1.00	0.90*	-0.10*	0.35	0.75

12305 kc

E-W Long Path 12 mc

Apr	May	Jun	Jul	Aug	Sep	Oct	Nov	Dec
0.70	0.70	0.45	0.60	0.60	0.50	-1.00	0.00*	(0.50)#
0.60	0.70	0.50	0.70	0.70	0.60	-1.00	0.10*	(0.30)#
0.60	0.60	0.40	0.90	0.80*	0.70	-1.00	-1.00*	(0.20)#
0.70	0.50	0.40	0.80	0.30*	0.80	-1.00	-0.65*	(0.10)*
0.10	0.40	0.35	0.80	0.20*	0.75	-1.00	-0.70*	(0.15)*
0.15	0.50	0.50	0.50	0.10*	0.20	-1.00	-0.30*	(0.05)#
0.05	0.50	0.30	0.45	0.10*	-0.40*	-1.00	-0.80*	(0.00)#
0.10	0.60	0.70	0.50	0.25*	-0.70	-1.00	(-1.00)#	(-0.20)#
0.35	1.00	1.35	1.20	0.20*	-1.00	-1.00	(-1.00)#	(-0.35)#
0.40	1.10	1.30	1.40	0.40*	-1.00	-1.00	-1.00*	-0.70*
0.80	1.00	1.10	1.20	0.40	-1.00	-1.00	-1.00*	0.20*
1.00	1.10	1.20	1.10	0.60	-1.00	-1.00	-1.00*	0.90*
1.05	1.20	1.10	1.20	0.80	-1.00	-1.00	-1.00	0.80*
1.10	1.10	1.20	1.30	0.65	-1.00	-1.00	-0.10	1.10*
0.95	0.70	1.05	1.10	0.30	-1.00	-1.00	0.40	0.90*
0.90	0.90	1.20	1.20	0.25	-1.00	-1.00	-1.00	0.20*
0.60	0.50	1.20	0.85	-0.30	-1.00	-1.00	-1.00	(-0.20)#
0.50	0.00	0.50	0.00	-0.45	-1.00	-1.00	-1.00*	(-0.10)#
0.70	0.00	0.20	0.00	-1.00	-1.00	-1.00	-1.00*	(-0.35)#
0.50	0.20	0.20	0.20	0.00	-1.00	-1.00	-1.00	-
0.90	0.25	0.20	0.50	0.20	0.50*	-1.00*	-1.00*	(0.25)#
0.75	0.45	0.30	0.30	0.20	0.75*	-0.30*	(0.60)#	-
0.80	0.50	0.40	0.40	0.35	0.90*	-0.15*	0.55#	(0.60)#
0.55	0.20	0.30	0.50	0.50	0.40	-1.00	0.30*	0.50#

TABLE 6.32 MONTHLY MEDIAN NORTHWAY - NOME 12305 kc Long Path E-W 12 mc
 1954 1955

	Jan	Feb	Mar	Apr	May	Jun	Jul	Aug	Sep	Oct	Nov	Dec	Jan	Feb	Mar	Apr	May	Jun
00-01	-0.40*	0.10*	-0.20*	-0.10	0.20	0.30	0.30	0.20	0.20	0.20	0.00	-	-	-	-	-	-	(1.0)#
01-02	-0.20*	0.00*	-0.25*	0.10*	0.10	0.30	0.30	0.20	0.40	0.35	0.30	-	1.0#	-	(0.6)#	-	-	(0.9)#
02-03	-0.20*	0.00*	-0.15*	0.20*	0.10	0.30	0.30	0.30	0.30	0.50	0.30	-	0.5#	-	0.6*	-	-	(0.8)#
03-04	-0.15*	0.00*	-0.30*	0.00*	0.15	0.10	0.10	0.40	0.40	0.30	0.10	-	-	-	(0.3)#	-	-	0.8*
04-05	0.50*	-0.10*	0.00*	0.10*	0.30	0.20	0.20	0.00	0.15	0.10	0.10	-	-	-	(0.4)#	-	-	0.6*
05-06	-1.00#	-0.30*	-0.40*	(0.10)#	0.30	0.20*	0.20*	0.00	0.25*	0.00	0.20	-	-	-	-	-	-	0.8*
06-07	(-0.40)#	-0.40#	-	-0.20*	0.20	0.10*	0.10*	-0.10*	-0.40*	0.00	-0.15	-	-	-	-	-	-	0.7*
07-08	-	-	-	-0.30*	0.20	0.10*	0.10*	-0.40*	(-0.45)#	-0.20*	-0.40*	-	-	-	-	-	-	0.6*
08-09	-	-	-	-0.20*	0.30	-0.10	-0.30*	(-0.50)#	-0.40*	-0.40*	-0.40*	-	-	-	-	-	-	(0.8)#
09-10	-	-	-	-0.20	0.30	0.40	-0.30	(-0.45)#	-0.40*	-0.40*	-0.45*	-	-	-	-	-	-	0.6
10-11	-	-	-	-0.10	0.40	0.35	-0.20	(-0.50)*	-0.10*	-0.10*	-0.10*	-	-	-	-	-	-	0.8
11-12	(-1.00)#	-	-	0.00	0.60	0.50	-0.20	(-0.40)*	-0.20	0.00	0.00	-	-	-	-	-	-	0.8
12-13	-0.40*	-	-	0.00	0.70	0.50	-0.25	(-0.40)*	-0.20	0.10	0.10	-	-	-	-	-	-	0.7
13-14	-0.50*	-	-	0.00	0.60	0.50	-0.30	(-0.40)*	-0.20	0.20	0.20	-	1.5#	-	-	-	-	0.6*
14-15	-0.50*	-	-	0.00	0.50	0.10	-0.30	(-0.40)*	-0.20	0.10	0.10	-	1.4#	-	-	-	-	0.5*
15-16	(-0.50)#	-	-	0.00*	0.20	0.10	-0.25*	-0.40*	-0.30	-0.20	0.10	-	1.3#	-	-	-	-	0.6
16-17	(-0.50)#	-	-	-0.50*	0.00	-0.10*	-0.40*	(-0.50)#	-0.20	-0.30	-0.20	-	-	-	-	-	-	(0.4)#
17-18	-	-	-	-0.20#	0.05	-0.10	-0.35*	-0.50*	-0.20	-0.10	-0.10	-	-	-	-	-	-	(0.3)#
18-19	-	-	-	0.20*	0.20*	0.00	-0.40*	-0.40*	-0.20	-0.10	-0.10	-	-	-	-	-	-	(0.3)#
19-20	-	-	-	0.10*	0.20	-0.20	-0.30	-0.30	-0.30	0.00	-0.20	-	-	-	-	-	-	(0.4)#
20-21	-	-	-	-0.10*	0.25	-0.15	-0.20	-0.20	-0.20	0.00	-0.30*	-	-	-	-	-	-	(0.4)#
21-22	-	0.10#	(-0.50)#	-0.15*	0.10	0.15	0.10	-0.20	-0.20	0.10	-0.20*	-	-	-	-	-	-	(0.7)#
22-23	-	0.30#	-0.10*	-0.20	0.10	0.20	0.20	0.05	-0.10	-0.10	-0.10*	-	-	-	-	-	-	(0.8)#
23-24	0.10#	0.30#	0.00*	0.00	0.30	0.20	0.25	0.20	0.20	0.00	-0.10	-	-	-	-	-	-	(1.0)#
																		(1.0)#

TABLE 6.33

MONTHLY MEDIAN

	1949
	June
00-01	-
01-02	0.30#
02-03	0.30#
03-04	0.90#
04-05	0.80#
05-06	1.20#
06-07	1.20#
07-08	1.15#
08-09	1.05#
09-10	1.00#
10-11	1.20#
11-12	0.95#
12-13	0.50#
13-14	0.65#
14-15	0.90#
15-16	1.20#
16-17	1.05#
17-18	0.35#
18-19	0.95#
19-20	0.70#
20-21	0.50#
21-22	0.45#
22-23	0.35#
23-24	0.70#

NORTHWAY - NOME

12305 kc Long Path E-W 12 mc

1955

	Jul	Aug	Sep	Oct
00-01	-	-	0.8*	(0.8)#
01-02	-	1.0#	0.8*	(0.6)#
02-03	(1.0)#	0.8*	0.9*	0.6
03-04	0.8*	0.8*	0.7*	(0.6)#
04-05	1.0#	0.6*	0.6*	(0.3)#
05-06	0.9*	0.8#	(0.5)#	-
06-07	0.8*	-	(0.5)#	-
07-08	0.8*	-	-	-
08-09	1.0	0.8*	-	-
09-10	1.1	(1.1)#	-	-
10-11	1.2	0.9*	-	(1.6)#
11-12	1.2	0.9	-	(1.3)#
12-13	1.1	0.8	(0.4)#	(1.6)#
13-14	1.2	0.8	(0.6)#	(1.6)#
14-15	1.0	0.6*	-	1.5*
15-16	0.8	0.5*	-	(1.5)#
16-17	0.4*	(0.4)#	-	1.6#
17-18	0.4*	(0.3)#	-	(1.3)#
18-19	(1.0)#	(1.0)#	-	-
19-20	(0.7)#	(0.6)#	(0.8)#	-
20-21	(0.8)#	(0.7)#	(1.0)#	-
21-22	(0.8)#	-	(0.9)#	-
22-23	-	(0.9)#	(0.5)#	-
23-24	-	(1.1)#	(0.9)#	(0.8)#

TABLE 6.34

MONTHLY MEDIAN

ANCHORAGE - PT. BARROW

12070 kc

S-N Long Path 12 mc

	1949						1950											
	Jul	Aug	Sep	Oct	Nov	Dec	Jan	Feb	Mar	Apr	May	Jun	Jul	Aug	Sep	Oct	Nov	Dec
00-01	0.75	1.30	1.30#	1.50	1.50	1.50*	(1.80)#	0.90*	1.50	1.35	1.20	1.10	1.40	(1.50)#	1.30	0.90	0.95	1.40
01-02	1.00	1.10	1.25#	1.30*	1.30*	1.30*	-	1.25*	1.60	1.40	1.30	0.90	1.10	(1.50)#	1.20	0.80	0.80	1.25
02-03	1.20	1.00	(1.20)#	1.20*	1.15*	1.50*	-	1.35	1.55	1.25	1.15	0.90	1.20	(1.20)#	1.10*	0.80	0.90	1.00
03-04	1.00	0.80	(1.10)#	1.30	1.00	1.50*	-	1.30	1.30	1.20	1.10	1.00	1.15	(0.80)#	1.20*	0.95	0.70	0.90
04-05	1.10	0.55	(1.10)#	1.00	1.00*	1.40*	-	1.40*	1.60	1.30*	1.20	1.20	1.15	(0.90)#	1.20*	0.80	0.80	0.90
05-06	1.30	0.80*	-	1.10	1.10	1.40*	-	1.30*	1.20*	1.20*	1.00	1.30	1.30	(0.90)#	1.00*	0.60*	0.40	0.80
06-07	1.40	0.70*	-	1.30*	1.00	1.25	(1.10)#	1.20*	1.20*	1.30*	1.00	1.40	1.25	(1.30)#	0.85*	0.50*	0.50	0.60
07-08	1.60	0.90*	-	1.00*	0.90*	1.20	(0.80)#	1.30*	1.20*	1.35*	1.25*	1.40	1.40	(1.20)#	(0.80)#	0.20*	0.45	0.40
08-09	1.50	1.20*	-	1.50#	1.20*	1.20	(0.50)#	-0.10#	1.35*	1.60*	1.40	1.40	1.45	(0.60)#	-	0.00*	0.20	0.25
09-10	1.50	1.35*	-	1.70*	1.60*	1.25	(0.60)#	1.55*	1.20*	1.70*	1.50	1.40	1.40	-	(0.45)#	-0.30	0.15*	0.00
10-11	1.50	1.20	(2.10)#	1.60	1.80	1.95	1.40*	1.70*	1.20	1.50*	1.40	1.50	1.30	-	0.00*	-0.10	0.20	0.00
11-12	1.50	0.90	(2.20)#	1.40	1.80	1.80	1.80*	1.50	1.40	1.50	1.50	1.40	1.30	(0.20)#	-0.30*	-1.00	-0.10	0.40
12-13	1.50	1.20*	(2.20)#	1.60	1.50	1.80	1.60*	1.40	1.80	1.50	1.30*	1.40	1.30	-	-0.30*	-0.20	0.30	0.80
13-14	1.50	1.00*	(2.00)#	1.40	1.75	1.95	1.75*	1.60	1.75	1.50	1.45*	1.50	1.40	-	-0.20*	-0.10	0.45	1.50
14-15	1.50	1.15*	(1.70)#	1.60	1.90	2.00	1.70*	1.65	2.00	1.35	0.90*	1.50	1.30	-	0.00*	0.45	0.80	0.70
15-16	1.55	0.60*	(2.10)#	1.80	1.85	2.10	1.80*	1.55	2.20	1.50	1.25*	1.50	1.30	-	-0.10*	0.70	0.60	0.00
16-17	1.50	0.30*	2.10#	1.60	1.60	2.00	1.90*	2.00	2.15	1.10	1.50*	1.40	1.20	-	0.10*	0.80	-0.10	0.05
17-18	1.20	0.40*	(1.50)#	1.80	1.65	1.50	1.10*	2.00	0.95	1.50*	1.05	1.00	0.80	-	0.10*	0.70	0.10	0.10
18-19	0.80	0.35*	(2.30)#	1.60	1.75*	1.20	(-0.25)#	1.05	1.80	1.30	1.40*	0.60	0.75	-	0.25*	0.70*	0.10*	-0.10
19-20	0.70	0.55*	(1.80)#	1.25	1.70*	(1.10)#	(0.15)#	0.60	1.70	1.70	1.00	1.00	1.10*	-	0.20*	1.30*	0.30	0.00
20-21	1.00	0.35*	(1.50)#	1.10*	1.80*	(1.40)#	-	0.90*	1.00	1.50	1.50*	1.00	1.00	-	0.75*	1.30*	0.50	0.40
21-22	0.80	0.50*	(1.40)#	1.50	1.70*	(1.50)#	-	1.40*	1.30*	1.50	1.20	0.95	1.15*	-	1.40*	1.30	1.40	0.40
22-23	0.55	0.80*	(1.50)#	1.50	1.60*	(1.30)#	(1.90)#	1.40*	1.50	1.50	1.50	1.20	1.40*	-	1.40*	1.25	1.25*	1.35
23-24	0.70	0.90*	1.30*	1.50	1.50	1.60*	(1.85)#	1.50*	1.65	1.20	1.20	1.10	1.45*	-	1.35*	1.20	0.80*	1.50

TABLE 6.35 MONTHLY MEDIAN SHEEP MOUNTAIN - PT. BARROW 12072.5 kc S-N Long Path 12 mc

	1954												1955					
	Jan	Feb	Mar	Apr	May	Jun	Jul	Aug	Sep	Oct	Nov	Dec	Jan	Feb	Mar	Apr	May	Jun
00-01	-0.10	0.30	-0.1		0.20	0.7	0.7	0.7	0.5	0.4	0.2	0.1	(0.6)#	0.5#	0.65#	0.6#	0.20#	0.15#
01-02	0.00	0.00*	-0.1		0.10	0.6	0.7	0.6	0.25	0.2	0.3	0.15	(0.5)#	0.6#	-	-	(0.2)#	0.0#
02-03	-0.40	-0.5*	-0.2		0.0	0.6	0.5	0.45	0.4	0.2	0.1	0.10	(0.2)#	0.5#	-	-	0.20#	0.1#
03-04	-0.45*	-0.4*	-0.4		0.0	0.5	0.4	0.15	0.3	0.3	0.1	0.15	-	-	-	-	0.15#	0.0*
04-05	-0.55*	-0.5*	-0.3		-0.2	0.35	0.4	0.2	0.35	0.15	0.2	-0.1	-	-	-	-	0.20#	0.0*
05-06	-0.30*	-0.5*	-0.3		-0.3	0.5	0.5	0.4	0.2	0.10	0.3	0.0	-	-	-	-	-0.10#	-0.1*
06-07	-0.3*	-0.5*	-0.2		0.0	0.45	0.5	0.5	0.35	0.2	0.2	0.0	-	-	-	-	-0.05#	-0.2*
07-08	(-0.3)#	-0.2*	0.0		-0.1	0.2	0.35	0.6	0.5	0.2	0.0	-0.4	-	-	-	-	-0.05#	-0.1*
08-09	-	(-0.5)#	-0.2		-0.15	0.2	0.5	0.5	0.3	0.1	-0.1	-0.3	-	-	-	-	0.04#	0.0*
09-10	-	-	-0.2*		-0.1	0.6	0.6	0.5	0.0	0.0	-0.2	-0.45	-	-	-	-	0.15#	0.1*
10-11	(-0.4)#	-	(-0.5)#		-0.1	0.7	0.6	0.4	-0.2	-0.1	-0.2	-0.3	-	-	-	-	0.10#	0.2
11-12	(-0.4)#	-	-		0.0*	0.7	0.7	0.35	-0.2	-0.2	-0.2	-0.4	-	-	-	-	0.15#	0.1
12-13	(-0.4)#	-	-		0.1*	0.7	0.7	0.25	-0.2	-0.2	-0.1	-0.4	0.60#	1.20#	-	-	(0.1)#	0.0*
13-14	(-0.4)#	-	-		0.0*	0.7	0.6	0.2	-0.2	-0.1	0.0	-0.3	-	-	-	-	-0.05#	0.0*
14-15	(-0.1)#	-	-		0.0*	0.6	0.5	0.2	-0.2	-0.1	-0.2	-0.5	-	-	-	-	0.15#	0.0#
15-16	(-0.4)#	(-1.00)#	-		-0.2*	0.5	0.6	0.1	-0.3	-0.2	-0.2	-0.5	-	-	-	-	0.15#	0.0#
16-17	-	-	(-0.5)#		-0.2*	0.5	0.1	0.0	-0.3	-0.2	-0.2	-0.5	-	-	-	-	0.15#	-0.10#
17-18	-	(-1.00)#	(-0.5)#		-0.4#	0.6	0.0	0.0	-0.3	-0.2	-0.3	-0.5	-	-	-	-	0.15#	-0.15#
18-19	(-0.3)#	-	(-0.4)#		0.0*	0.25	0.5	-0.1	-0.3	0.0	-0.1	-0.5	-	-	-	-	0.30#	0.10#
19-20	(-0.4)#	(0.0)#	-0.4*		0.4*	0.3	0.3	0.2	-0.1	0.0	0.1	-0.4	-	-	-	-	0.25#	0.05#
20-21	(0.00)#	0.1#	0.00		0.1*	0.35	0.6	0.1	0.4	0.0	0.0*	-0.4	-	-	-	-	0.20#	0.05#
21-22	0.00*	0.1*	0.2		0.0	0.55	0.5	0.6	0.8	0.5	0.0	0.4	0.5#	0.4#	0.8	0.8	0.40#	-0.1#
22-23	0.10*	0.25	0.5		0.2	0.4	0.5	0.6	0.8	0.4	0.1	-0.1	0.7#	0.4#	0.2	0.2	0.60#	0.05#
23-24	0.00*	0.4	0.1		0.1	0.3	0.5	0.6	0.65	0.5	0.25	0.1	(0.6)#	0.1#	0.3	0.3	0.40#	0.15#

TABLE 6.36

MONTHLY MEDIAN 12 mc

	1955
	July
00-01	0.40#
01-02	0.25#
02-03	0.20#
03-04	0.20#
04-05	0.1*
05-06	0.05#
06-07	0.1*
07-08	0.1*
08-09	0.4*
09-10	0.4*
10-11	0.5
11-12	0.4
12-13	0.4*
13-14	0.35*
14-15	0.3*
15-16	0.30#
16-17	0.10#
17-18	0.50#
18-19	0.25#
19-20	0.35#
20-21	0.35#
21-22	0.20#
22-23	0.40#
23-24	0.4#

SHEEP MOUNTAIN - PT. BARROW

12072.5 kc Long Path S-N

Aug	Sept	Oct
(1.5)#	0.25#	0.40#
0.7*	0.15*	0.50#
0.4*	0.30*	0.40#
0.4*	0.20*	0.25#
0.2	0.00*	0.25#
0.2*	(0.15)#	0.20#
0.4*	(-0.10)#	0.40#
0.2*	(0.20)#	0.30#
0.0*	0.15#	-
0.40#	-0.05#	1.00#
0.35#	-0.20#	1.35#
-0.20#	0.40#	1.08#
-	0.20#	0.95#
-	0.00#	1.0#
0.50#	-	1.1#
-	-	1.0#
-	-	0.8#
-	-	1.30#
1.55#	0.20#	-
0.8#	0.30#	0.25#
0.3*	0.40*	0.40#
0.45#	0.55*	0.80#
1.1#	0.65*	0.80#
0.6*	0.40*	0.40#

SECTION V
OVERALL CONCLUSIONS

The conclusions stated below summarize the results of the analyses made of the transmission data secured during "Experiment Aurora" from June 1949 through October 1955. These analyses were made under Task A of Contract Nos. DA-36-039 SC-56739 and SC-71137. Reference is also made to results of 12 mc/s backscatter soundings and forward scatter experiments as well as measurements of ionospheric absorption performed under Task B of these contracts.

The period June 1949 - October 1955 extended over both years of high and low solar activity. The activity during the year 1949-50 corresponded to that of an average maximum of sunspot activity (the preceding maximum in 1947 was one of the largest on record) while a minimum of sunspot activity occurred during 1954. The transmissions were made on 4, 8 and 12 mc/s over short paths having a range of approximately 350 km and long paths with an approximate range of 1100 km. The paths were extended in the South-North as well as the East-West directions over the Territory of Alaska. Thus a total of 12 HF transmission circuits were in continuous operation for a period of 76 months. The E-W paths were roughly parallel to the auroral zone while at least the long S-N paths crossed the auroral zone. College, Alaska was the receiving terminal point for the short paths and less than 200 km from the midpoint of the long paths.

1. Signal In-Time

a) Short paths. The best frequency for transmission over the short paths was 4 mc/s throughout the transmission experiment. The average monthly percentage signal in-time over the 76 month period was 76.5.

b) Long paths. The best frequencies for transmission over the long paths were 8 and 12 mc/s, the former being slightly more favorable. The average monthly per-

centage of signal in-time on 8 mc/s for the 76 month period was 62.5.

The seasonal variation of signal in-times have been studied for all frequencies and paths over the entire 76 month period. A clear seasonal effect was established for the 8 and 12 mc/s long paths only. These paths showed a significant increase in signal in-time during the summer months.

2. Signal Outages

The signal outages over the short 4, 8 and 12 mc/s transmission paths have been analyzed in detail for a year of high solar activity (1949-50) and a year of low solar activity (1954). At least 80 per cent, and probably almost 100 per cent, of the signal outages on the short paths were found to be caused by ionospheric absorption in both years. It appears that there is almost always sufficient ionization in the upper atmosphere to sustain propagation of detectable signals up to frequencies of 12 mc/s.

Backscatter soundings carried out at 12 mc/s for 8 months during 1956 showed the presence of sufficient ionization for reception of groundscatter echoes via F or sporadic E ionization during all 24 hours of the day in the 4 summer months and during 17 hours of the day in the 2 mid-winter months.

The ionospheric D-layer absorption of the short path transmissions was analyzed on the basis of the College vertical incidence soundings and found to be subject to a marked seasonal variation with large maxima in signal out-time occurring during the equinoctial periods. Studies of the diurnal variation of signal outage during 1954 have shown that the absorption is mainly a daytime phenomenon with its daily peak occurring in the early mid-day hours. This conclusion has been confirmed by later measurements of ionospheric absorption performed at College and Barrow using the extraterrestrial radiation technique. Absorption measurements at College moreover indicate that the absorption is fairly uniform over a region of roughly

100 km diameter while simultaneous measurements at College and Barrow show that the disturbed region often extends over distances of at least 800 km.

The signal outages over the short paths were strongly correlated with geomagnetic activity (based on the daily K-index sums for College) in both 1949-50 and 1954. The mean diurnal variations of absorption and magnetic activity were out of phase however, since the absorption reached its peak during the daytime hours and the magnetic disturbances near magnetic midnight (shortly after local midnight).

The signal out-time has been found to vary with the relative sunspot numbers both seasonally and yearly. The signal out-time was greater in years of high solar activity than in periods of low solar activity. The outage time on all frequencies during 1949-50 was about twice that of 1954 for the short paths.

The outage time for the long paths has not been studied in detail but the situation can be inferred to be similar to that on the short paths since the absorption measurements at College were made at a point near the midpoint of the long paths. The increased zenith angles involved in propagation over the longer paths would increase the length of path through the absorbing region, with a resultant enhancement of the absorption effects.

3. Median Signal Strength

It has been noted that with regard to signal in-time 4 mc/s was the most favorable frequency for transmission over the short paths and 8 or 12 mc/s the best frequencies for the long path transmissions. This makes it important to summarize also the results for the seasonal and daily variation of the median monthly signal strength (measured in log microvolts) for these frequencies and paths. The summary is made in tabular form below for the two years of respectively high and low solar activity which have been studied in detail. The tables give for the 4 mc/s short paths and the 12 mc/s long paths: the season considered, the yearly period, a rough indication

of the daily variation during that season, and the average daily minimum and maximum of the monthly median for the season. Finally, the range of variation based on the average seasonal values of the daily minimum and maximum is stated for each of the two yearly periods. Average values for the S-N and E-W paths are given except when there was a significant difference between the values for the two paths.

4 MC/S SHORT PATHS. MEDIAN MONTHLY SIGNAL STRENGTH

Season	Year	Daily Variation	Daily Minimum		Daily Maximum	
			AST	Log uV	AST	Log uV
Winter	1949-50	Fairly Uniform	Noon	0.5	17-18	1.2
	1954-55	Large midday peak	19-20	0.6	14-15 (09-16 above 1.5)	2.3
Equinox	1949-50	Fairly uniform	08-10	0.0	19-21	0.9-1.0
	1954-55	Fairly uniform	05-06	0.7	11-18	1.5-1.7
Summer	1950	Midday minimum	09-11 (09-13)	0.3 0.4)	21-23	2.0
	1955	Midday minimum	12-13 (09-15)	1.2 below 1.8)	20-23	2.5

Yearly range of variation: 1949-50 -0.2 - 2.2
1954-55 0.6 - 2.5

12 MC/S LONG PATHS. MEDIAN MONTHLY SIGNAL STRENGTH

Season	Year	Daily Variation	Path	Daily Minimum AST Log uV	Daily Maximum AST Log uV
Winter	1949-50	Midday maximum		07-09 0.25 18-21 0.5	10-18 1.1
	1954-55	Probably similar to 1949-50			
Equinox	1949-50	Fairly uniform	S-N	03-04 1.2	15-16 1.9
	1949-50	Midday maximum	E-W	06-07 0.2	14-15 1.3
	1954-55	Similar to E-W 49/50		07-09 -0.2	14-15 1.0
Summer	1950	Fairly uniform	S-N	18-19 0.7	10-14 1.4
	1950	Midday maximum	E-W	18-19 0.1	09-14 1.0
	1955	Fairly uniform		16-18 0.3	09-12 0.9
Yearly range of variation:		1949-50	0.1 - 1.9		
		1954-55	-0.2 - 1.3		

4. Propagation Modes

The data available for studies of the propagation modes consist basically of the tabulations of hourly median signal strength and the results of the vertical incidence soundings at College. The latter indicate the regular ionospheric layers present over College and provide hourly values of the critical frequencies and virtual heights of these layers. The hourly values of the ionospheric parameters permit estimates of the usable frequencies and calculation of the maximum usable frequency for a given path.

A detailed study has been made of possible relations between the noon and midnight signal strengths over the long 4, 8 and 12 mc/s paths and the maximum usable frequencies for these paths. The study was extended over the entire period 1949-55. However, no simple, statistical relationship could be established between the received signal strengths, averaged over each of the four yearly seasons, and the corresponding critical frequencies or MUFs. This indicates that a general understanding of the propagation modes involved in auroral zone HF transmission requires more detailed information on the ionosphere than that provided by the parameters critical frequency and virtual height even when these are obtained near the midpoint of the transmission paths. It may be conjectured that the failure to correlate variations in the observed signal strength with maximum usable frequency is due to a combination of circumstances involving: i) ionospheric absorption, ii) the high incidence of irregular ("sporadic") ionization in auroral latitudes, iii) the fact that the virtual height and true height of ionospheric layers are not simply related in high latitudes owing to the marked influence of the earth's magnetic field, iv) inhomogeneous transmission data.

Since the general propagation modes for the "Experiment Aurora" transmissions cannot be established from the existing data, one must be content with partial conclusions limited to special frequencies, paths and periods. The following results for some special cases should be mentioned.

a) The transmission of the 12 mc/s signals over the short paths were found to depend primarily on sporadic ionization. This was ascertained from the fact that regular F-layer propagation was marginal during 1949-50 and impossible during 1954-55. The regular E-layer could not at any time have sustained the propagation. A significantly higher signal in-time was recorded for the E-W than the S-N path. This indicates either a preferential orientation of the sporadic ionization along paral-

nels to the auroral zone or a preferential statistical orientation of the irregularities in the ionization such that forward scatter propagation in the E-W direction was favored compared to the S-N direction. The former interpretation is compatible with the results on the distribution of the sporadic E ionization obtained from the 12 mc/s backscatter soundings during 1956.

b) The data for the 4 mc/s short paths showed a large daytime peak in the hourly median signal strength during the winter of 1954-55, while no such peak was observed during the winter of 1949-50. The MUF for F2-propagated daytime signals on the short 4 mc/s paths were found to be 6 mc/s during the winter of 1954-55 but as high as 12 mc/s for the winter of 1949-50. Therefore conditions were favorable for daytime F-layer propagation of the 4 mc/s short path signals during the winter of 1954-55 but not during the winter of 1949-50. The midday depression observed in the median signal strength for these paths during the summers of 1949-50 and 1954-55 are attributed to absorption. In general the daytime transmission of the 4 mc/s signals over the short paths can be associated with regular F or E layer propagation throughout the period 1949-55. The yearly and seasonal variations observed in the daytime signal level can be explained in terms of the normal changes in the F2 and E layers with the sunspot cycle, solar control of the ionization, and D layer absorption.

c) Detailed variations in the relative daytime strength of the signals propagated in the S-N and E-W directions over the short 4 mc/s paths during 1954-55 can be explained by the combined effect of ionospheric irregularities and absorption, but not by any one of these factors alone. The daytime signals on the 4 mc/s short paths were propagated by a regular E-layer mode during the period winter 1954-55 through summer 1955. The above result shows that the development of a mathematical theory of forward scattering of radio waves by ellipsoidal blobs having the shape of prolate spheroids and aligned with their major axis parallel to the earth's mag-

netic field is of importance to the understanding of HF propagation in and near the auroral zone.

d) Daytime transmission of the 12 mc/s signals over the long paths is readily associated with F2-layer propagation during all seasons of the year of high solar activity 1949-50 (MUF above 12 mc/s). During 1954-55 daytime propagation by the F2-layer was marginal or absent (MUF below 12 mc/s). Some aspects of the daytime transmission of 12 mc/s signals over the long paths cannot be understood solely in terms of F2-layer conditions and absorption, and remain unexplained.

e) Nighttime transmission over the short and long paths must be associated partly with F-layer ionization and partly with "Night-E" layers and sporadic E ionization. The semi-regular formation of night-E layers and the high incidence of nighttime sporadic E ionization is a characteristic feature of the ionosphere in and near the auroral zone. Our knowledge of the nighttime E ionization in high latitudes is as yet too incomplete and unsystematic to warrant definite conclusions about the nighttime HF propagation modes.

5. Fading Rates

The transmission data from "Experiment Aurora" do not permit fading rates to be established and studied because of the insufficient time-resolution of the records. The backscatter soundings at 12 mc/s have shown that the fading rates of groundscatter echoes propagated by the F-layer are of the order of 1-2 cps while groundscatter echoes and direct backscatter from sporadic E ionization has fading rates between 4 and 8 cps. Backscatter echoes from auroral ionization fade rapidly with rates varying from 25 to 200 cps.

6. Auroral Ionization

Continuous backscatter sounding observations at 12 mc/s during 8 months of 1956 indicate that auroral ionization affecting HF transmission occurred 20 per cent of the

time. Although this figure strictly speaking is valid for that year only (when solar activity was at a medium level), no great variations are expected in it over a sunspot cycle. This expectation is based on the observation that near the auroral zone the incidence of auroras does not appear to vary greatly during the sunspot cycle. The differences observed in the auroral phenomena between years of high and low solar activity are related more to the intensity and geographic distribution of the auroral displays than to changes in their number or duration. The backscatter soundings and forward scatter pulse experiments performed at 12 mc/s further indicate that the effect of auroral ionization on point-to-point HF transmissions near the auroral zone is to cause garbling of the signals by interaction of direct and back-scattered components rather than to cause interruption of the transmission. However, it should be noted that interruptions in circuit transmissions which are propagated by ionospheric modes, may occur for shorter periods of time due to heavy absorption associated with the most intense phase of the auroral display.

CONCLUSIONS ON FURTHER ANALYSIS OF TRANSMISSION DATA

The summary given above under "Overall Conclusions" state the most important results of the analyses of the transmission data secured under "Experiment Aurora". Further details and results of secondary importance may be found in Interim Scientific Report No. 1, and Final Report Task A and B, Contract No. DA-36-039 SC-56739 as well as Final Report Task B, Contract No. DA-36-039 SC-71137 and the present report. Reference is also made to Final Report Task E, Contract No. DA-36-039 SC-56739 and to Technical Report No. 1, Contract No. DA-36-039 SC-71137.

The experience from the studies performed or attempted during the last contract year indicate that the point of rapidly diminishing returns has been reached in the analysis of the transmission data from "Experiment Aurora". It is concluded that no new important results are likely to be gained from further analysis.

SECTION VI
RECOMMENDATIONS

It is recommended that no further analysis of the transmission data secured in course of "Experiment Aurora" be undertaken. Further investigations of HF propagation in and near the auroral zone should be based on new experiments. In this connection we recommend that new experiments aim at the combination of pulse techniques including backscatter soundings with measurements of ionospheric absorption based on the extraterrestrial radiation technique as well as studies of the Luxemburg effect in the arctic ionosphere.

It is finally recommended that theoretical studies of forward scattering of radio waves in field-aligned ellipsoidal irregularities in the ionosphere be encouraged.

SECTION VII

PERSONNEL

C. T. Elvey	Project Supervisor
L. Owren	Associate Professor of Geophysical Research
G. C. Rumi	Assistant Professor
C. G. Little	Assistant Supervisor
L. A. Ware	Physicist
Merle J. Young	Electronic Technician
Eleanor Johnson	Technician
Ardith Burns	Technician
Georgia Burton	Technician
Betty Cornett	Technician
Murial Davis	Technician
Carolyn Quimby	Technician
Leta Thurman	Technician
Jean Voigt	Technician